

# #Pannelli Ponzio







# Ponzio, dal 1941

## *Ponzio, from 1941*

Ponzio è un'azienda italiana specializzata nella produzione di sistemi per serramenti in alluminio. Fondata negli anni '40, l'azienda si è distinta per la sua costante attenzione all'innovazione e alla ricerca di soluzioni sempre più avanzate, in grado di garantire prestazioni elevate in termini di sicurezza, comfort termico e acustico, design e funzionalità, con particolare attenzione alle finiture superficiali, di cui offre un'ampia gamma tecnologicamente avanzata.

Prestazioni impeccabili, design esclusivo e altissima affidabilità dei suoi prodotti - facciate, finestre, porte e sistemi frame less - fanno di Ponzio un partner di riferimento capace di soddisfare appieno le esigenze sia del progettista che del cliente. Tutto sostenuto da costanti investimenti in ricerca, tecnologia, innovazione e creatività: per ottenere risultati eccellenti e mantenere posizioni di leadership nel mercato. La costante attenzione di Ponzio verso la qualità, l'ambiente e la sicurezza, ha portato l'azienda ad associarsi al GBC Italia che persegue lo sviluppo e l'adattamento del marchio LEED alla realtà italiana.

*Ponzio is an Italian company specialized in the production of aluminum window and door systems. Founded in the 1970s, the company has distinguished itself for its constant attention to innovation and the search for increasingly advanced solutions, capable of ensuring high performance in terms of safety, thermal and acoustic comfort, design, and functionality, with particular attention to surface finishes, for which it offers a technologically advanced range. Impeccable performance, exclusive design, and high reliability of its products - facades, windows, doors, and frameless systems - make Ponzio a reference partner capable of fully satisfying the needs of both the designer and the customer.*

*All supported by constant investments in research, technology, innovation, and creativity: to achieve excellent results and maintain positions of leadership in the market. Ponzio's constant attention to quality, the environment, and safety has led the company to associate with GBC Italia which pursues the development and adaptation of the LEED brand to the Italian reality.*



1941 - 1970



1971 - 1975



1976 - 1979



1981 - 1982



1983 - 1990



# Stabilimenti

## *factories*

Per rispondere alle esigenze di un mercato sempre più esigente e competitivo, Ponzio ha investito in una moderna struttura produttiva, sviluppata su oltre 60.000 metri quadrati coperti nello storico stabilimento di Pineto, dove sono impiegate le più avanzate tecnologie di lavorazione dell'alluminio. Inoltre, l'azienda dispone di un grande magazzino a Roma e di un flagship store a Milano, punto di riferimento per architetti, designer e serramentisti del nord Italia.

Grazie alla qualità dei propri prodotti e all'elevato livello di servizio offerto ai propri clienti, Ponzio è riuscita ad affermarsi anche a livello internazionale, con la presenza di filiali in Polonia, Ucraina e India. Inoltre, l'azienda collabora con importanti partner commerciali in Europa, America Latina e Asia.

Il successo di Ponzio si fonda sulla capacità di coniugare tradizione e innovazione, esperienza e creatività, artigianalità e tecnologia. L'azienda è impegnata a mantenere elevati standard di qualità e sostenibilità in ogni fase della propria attività, dalla progettazione alla produzione, dalla commercializzazione al servizio post-vendita.

*To meet the needs of an increasingly demanding and competitive market, Ponzio has invested in a modern production facility developed over more than 60,000 square meters of covered space in the historic Pineto plant, where the most advanced aluminum processing technologies are employed. Additionally, the company has a large warehouse in Rome and a flagship store in Milan, a reference point for architects, designers, and window manufacturers in northern Italy. Thanks to the quality of its products and the high level of service offered to its customers, Ponzio has also succeeded internationally, with subsidiaries in Poland, Ukraine, and India. Furthermore, the company collaborates with important commercial partners in Europe, Latin America, and Asia.*

*The success of Ponzio is based on the ability to combine tradition and innovation, experience and creativity, craftsmanship and technology. The company is committed to maintaining high standards of quality and sustainability at every stage of its business, from design to production, from marketing to after-sales service.*



# Indice

*Index*

<b>Introduzione</b> <i>Introduction</i>	<b>4</b>
<b>Collezione Plana</b> <i>Plana collection</i>	<b>8</b>
<b>Collezione Linea</b> <i>Linea collection</i>	<b>38</b>
<b>Collezione Linea Inserti</b> <i>Linea collection with inserts</i>	<b>62</b>
<b>Collezione Linea vetro</b> <i>Linea collection with glass</i>	<b>84</b>
<b>Collezione Bugnati</b> <i>Bugnati collection</i>	<b>96</b>
<b>Maniglie e Maniglione</b> <i>Handles</i>	<b>138</b>
<b>Sezione Tecnica</b> <i>Technical section</i>	<b>152</b>
<b>Finiture</b> <i>Finishes</i>	<b>172</b>

# Collezione Plana

## Tecnologia, semplicità ed Eleganza

Plana, il marchio innovatore dei pannelli in alluminio, è il precursore dei tempi con i suoi portoncini Ponzio Pannelli. Queste esclusive novità dei portoncini d'ingresso sono un importante riferimento di stile e tendenze per la nuova stagione della casa. Plana è un brand che investe nella ricerca e nella progettazione continua, ed è proprio grazie a questo impegno che è stato creato lo stabilimento di produzione Plana. Situato nella zona industriale di Pineto, lo stabilimento è il fiore all'occhiello del quartier generale Ponzio, coprendo oltre 60mila metri quadrati. I portoncini Plana sono progettati e prodotti direttamente a casa Ponzio, il che li rende unici e di grande valore.

*Plana, the innovative brand of aluminum panels, is the forerunner of the times with its Ponzio Panels front doors. These exclusive novelties of the entrance doors are an important reference of style and trends for the new season of the house. Plana is a brand that invests in continuous research and design, and it is precisely thanks to this commitment that the Plana production plant was created. Located in the industrial area of Pineto, the plant is the flagship of the Ponzio headquarters, covering over 60,000 square meters. Plana front doors are designed and produced directly at the Ponzio home, which makes them unique and of great value.*



Ponzio  
oan  
nel  
i





Modello / Door Model: Prima  
Finiture / Finishes: Cemento Sand MBCT11 Marbel, Anodizzato Bronzo Spazzolato QXBR Anodize  
Maniglione / Handle: RAIN 600 BU3468





Modello / Door Model: Plana - Prima  
Finiture / Finishes: Cemento Sand MBCT11 Marbel, Anodizzato Bronzo Spazzolato QXBR Anodize  
Maniglione / Handle: RAIN 600 BU3468

## **Esempio Varianti Finiture / Possible Variants Finishes**

Per ogni modello molteplici combinazioni di finiture, colori e inserti / For each model multiple combinations of finishes, colors and inserts



**Augusta 1516**



Augusta 1516

Finitura / Finishes:

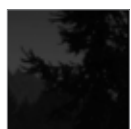

Night 51  
Starox

Inserto / Insert:



Iron Fine

Maniglione / Handle:



Fashion - Inox



Augusta 1516

Finitura / Finishes:



Rovere 25  
Uberal HD

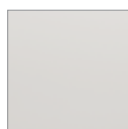

Bianco Puro  
K9010 RAL

Inserto / Insert:



Iron Fine

Maniglione / Handle:



Mitica - Inox



Augusta 1516

Finitura / Finishes:



Pirite Normal  
Velvet



Bambù Normal  
Velvet

Inserto / Insert:



Anodizzato nero

Maniglione / Handle:



Fashion - Nero

# Collezione Plana / Plana Collection

Pannelli con inserti in alluminio da 10mm o da 2mm / Panels with 10mm or 2mm aluminum inserts



Dalmine 1532



Cantù Sx1529



Ermitage 1519

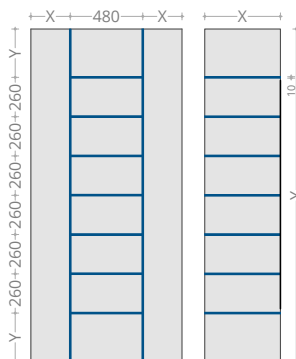

Dalmine 1532

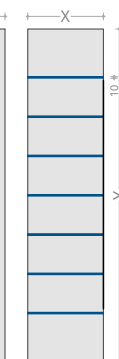

Cantù 1412

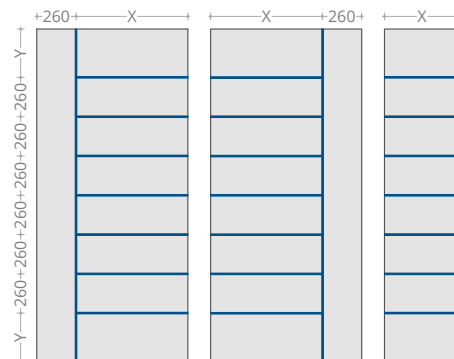

Cantù Sx1529

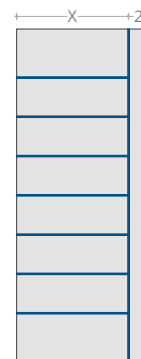

Cantù Dx1530

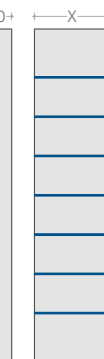

Cantù 1412

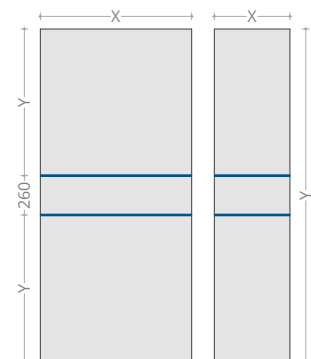

Ermitage 1519

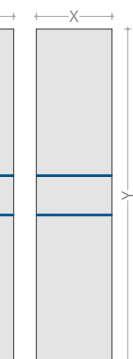

Ermitage 1419

 Insetto in alluminio

I disegni sono rappresentati in scala: 1000 mm di base per 2200 mm di altezza ; Y ha valore variabile tra 300 e 900 mm, X ha un valore variabile tra 80 mm e i 160 mm





Mori 1521



Bijou Sx1533



Flou 1537

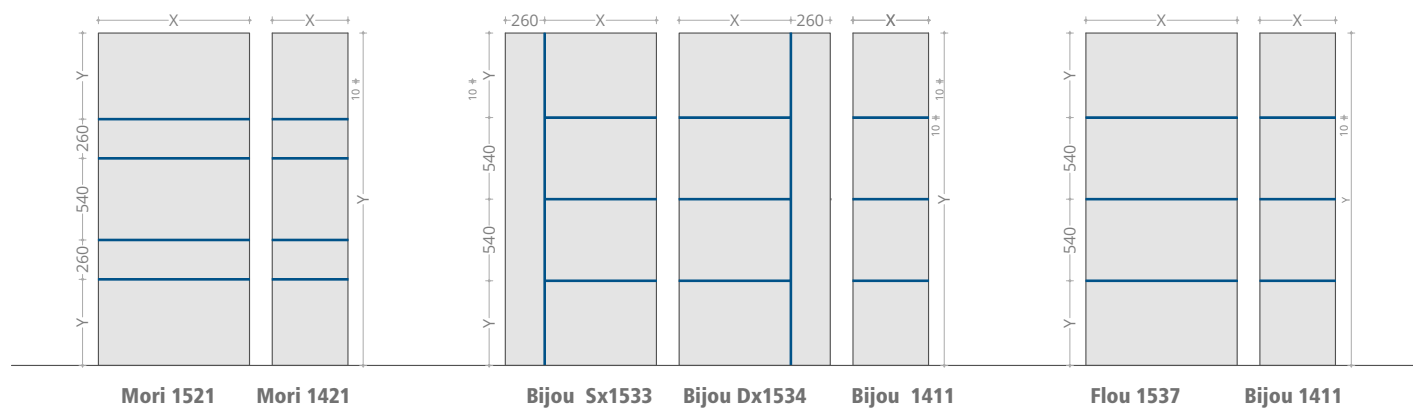

 Inserto in alluminio

I disegni sono rappresentati in scala: 1000 mm di base per 2200 mm di altezza ;  $Y$  ha valore variabile tra 300 e 900 mm,  $X$  ha un valore variabile tra 80 mm e 160 mm



Modello / Door Model: Plana 2 Ante Asimmetriche Lx+Gl  
Finiture / Finishes: Specchio Fine BDSH51 Brased, Blu Persia Fine BDBP51 Brased  
Maniglione / Handle: Letizia BU890124



## Collezione Plana / Plana Collection

Pannelli con inserti in alluminio da 10mm o da 2mm / Panels with 10mm or 2mm aluminum inserts



Albo 1523



Getty 1522



Holon Sx1538

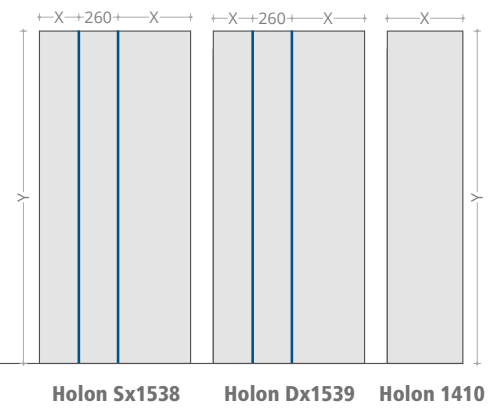
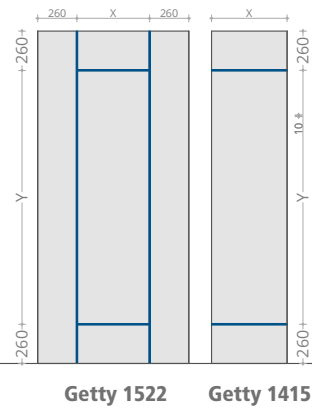
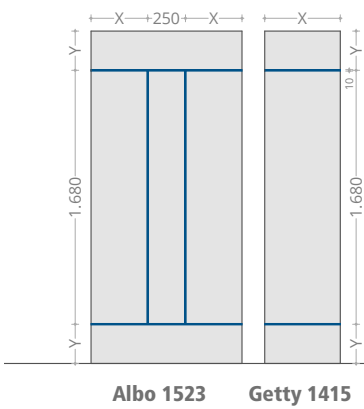

 Insetto in alluminio

I disegni sono rappresentati in scala: 1000 mm di base per 2200 mm di altezza ; Y ha valore variabile tra 300 e 900 mm, X ha un valore variabile tra 80 mm e 160 mm



Modello / Door Model: Lx-Plana 1Anta  
Finiture / Finishes: Marbel Terra Di siena 11, Marbel Snow MBSW51  
Maniglione / Handle: Letizia BU890124  
Inserto/ Insert: BDTG11 Grigio Tungsteno

# Pannelli Plana Inserti

## Straordinariamente Unici





Modello / Door Model: Lx-Plana 1Anta  
Finiture / Finishes: Marbel Terra Di siena 11, Marbel Snow MBSW51  
Maniglione / Handle: Letizia BU890124  
Inserito/ Insert: BDTG11 Grigio Tungsteno

## **Esempio Varianti Finiture / *Possible Variants Finishes***

Per ogni modello molteplici combinazioni di finiture, colori e inserti / *For each model multiple combinations of finishes, colors and inserts*



**Holon Sx1538**





Holon Sx1538

Finitura / Finishes:



Ral 9010  
RAL



Blu Klein Fine  
Brased

Inserto / Insert:



Iron Fine

Maniglione / Handle:



Trendy - Inox



Holon Sx1538

Finitura / Finishes:



Gold Ultra  
Brased

Inserto / Insert:



Grigio Tungsteno

Maniglione / Handle:



Puntatore - Nero



Holon Sx1538

Finitura / Finishes:



Pioppo 35  
Uberal HD



Iron Ultra  
Brased

Inserto / Insert:



Iron Fine

Maniglione / Handle:



Rain 600 - Inox

Modello / Door Model: Lx-Plana 1 Anta Con Due Fianchi Luce Fissi  
Finiture / Finishes: Verde Artico Anver Polycrom, Nero Grinz Grine Polycrom  
Maniglione / Handle: Maniglione Gloria BU890094  
Inserto/ Insert: Inox Bond 52 STIB52

# Collezione Plana / Plana Collection

Pannelli con inserti in alluminio da 10mm o da 2mm / Panels with 10mm or 2mm aluminum inserts



Pitti Dx1525



Louvre 1520



Vitra 1540

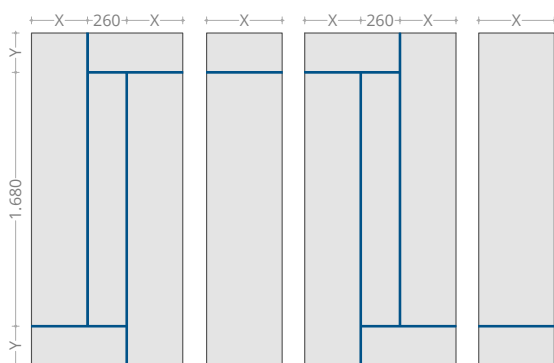

Pitti Dx1525 Pitti 1413 Pitti Dx1527 Pitti 1414

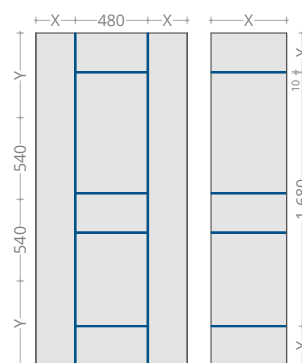

Louvre 1520 Louvre 1420

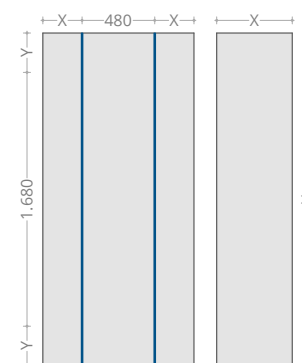

Vitra 1540 Holon 1410

 Inserto in alluminio

I disegni sono rappresentati in scala: 1000 mm di base per 2200 mm di altezza ; Y ha valore variabile tra 300 e 900 mm, X ha un valore variabile tra 80 mm e i 160 mm



Modello / Door Model: Lx-Plana 1 Anta Con Due Fianchi Luce Fissi  
Finiture / Finishes: Verde Artico Anver Polycrom, Nero Grinz Grine Polycrom  
Maniglione / Handle: Maniglione Gloria BU890094  
Inserto/ Insert: Innox Bond 52 STIB52



## **Esempio Varianti Finiture / *Possible Variants Finishes***

Per ogni modello molteplici combinazioni di finiture, colori e inserti / *For each model multiple combinations of finishes, colors and inserts*



**Pitti Dx1525**

---



Pitti Dx1525

Finitura / Finishes:



Thai 21  
Polycrom



Verde Micaceo  
Polycrom

Inserto / Insert:



Iron Fine

Maniglione / Handle:



Letizia - Inox



Pitti Dx1525

Finitura / Finishes:



Ciliegio Opaco 31  
Uberal HD



Ciliegio Opaco 31  
Uberal HD

Inserto / Insert:



Grigio Tungsteno

Maniglione / Handle:



Rain 600 - Inox



Pitti Dx1525

Finitura / Finishes:



Snow  
Marbel



Cemento Sand  
Marbel

Inserto / Insert:



Iron Fine

Maniglione / Handle:



Zen - Cromo/Satinato

# Collezione Plana / Plana Collection

Pannelli con inserti in alluminio da 10mm o da 2mm / Panels with 10mm or 2mm aluminum inserts



Melbourne 1536



Scotland DX1528



Lino 1535

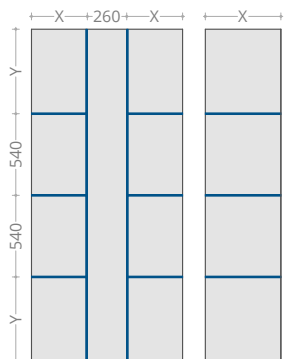

Melbourne 1536 Bijou 1411

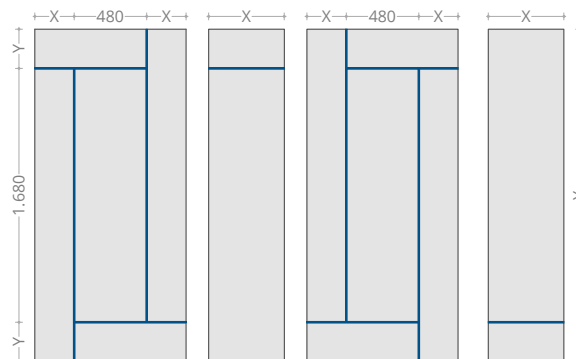

Scotland Dx1528 Pitti 1414 Scotland Dx1526 Pitti 1414

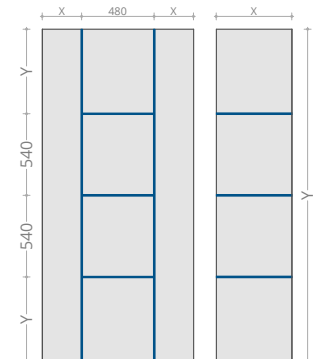

Lino 1535 Bijou 1411

Inserto in alluminio

I disegni sono rappresentati in scala: 1000 mm di base per 2200 mm di altezza ; Y ha valore variabile tra 300 e 900 mm, X ha un valore variabile tra 80 mm e i 160 mm





Modello / Door Model: Lx-Plana 1 Anta  
Finiture / Finishes: Uberal Noce Opaco 41 UBNC41, Corten 11-3D  
Maniglione / Handle: Maniglione Gloria BU890094  
Inserto / Insert: Inox Bond 52 STIB52

## Inserti in alluminio: il cuore della collezione

Plana è la materializzazione del concetto di innovazione nel mondo dei portoncini d'ingresso: il primo pannello con doppia anima flessibile (versione da 40 mm). Il massimo delle prestazioni: è questo il must che rende Plana unico nel suo genere. Da oggi, infatti, con la nuova tecnologia e l'inserimento della doppia anima flessibile, oltre a migliorare incredibilmente le prestazioni, questo prodotto innovativo sul mercato consente di controllare la dilatazione termica derivante dall'irraggiamento nella parte esterna. Inoltre, grazie all'inserimento della seconda anima flessibile, permette di controllare la dilatazione interna dovuta alla forte escursione termica tra la temperatura interna (ambiente riscaldato) e la temperatura esterna, soprattutto nei periodi invernali e in zone con forte escursione tra giorno e notte

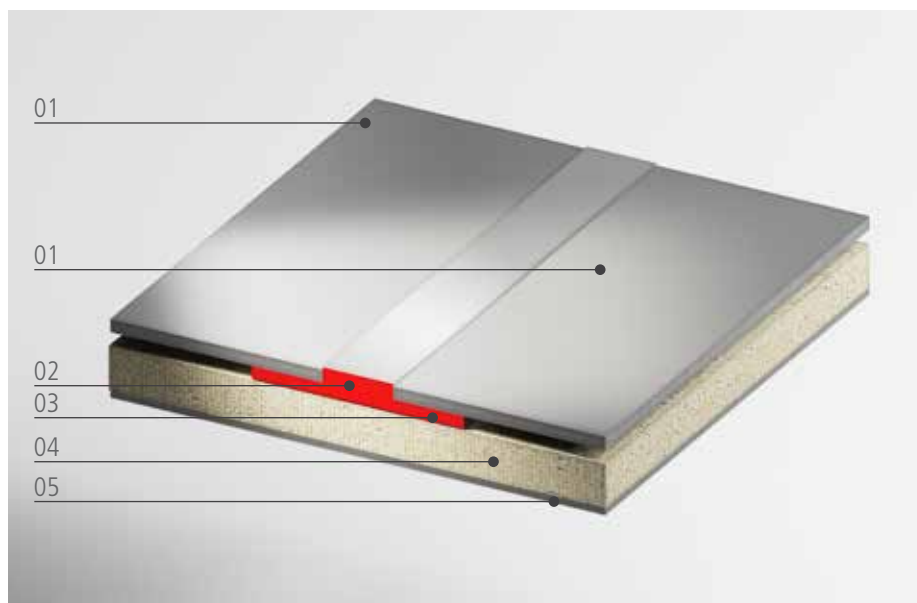

- 01 Lamiera in alluminio 1,2 mm
- 02 Interconnessione lamiera con profilo in alluminio estruso **10 mm** -brevetto
- 03 Inserto in alluminio
- 04 T.H.S. fibra naturale
- 05 Lamiera in alluminio 0,4 mm

- 01 Aluminum sheet 1,2 mm
- 02 Sheet inter-connection with outline in anodized aluminum (patented system)
- 03 Aluminum insert
- 04 T.H.S. natural fibre
- 05 Aluminum sheet 0,4 mm

Per le finiture disponibili degli inserti da 10 mm vedere pag. 172

## Alluminum inserts: the collection's heart

Nothing as PLANA has never seen before. It might be the commercial advertising launching the Ponzio Pannelli's collection program that, apart from the double core, put its great Heart into work. Great as the strengths of the Ponzio team focusing on the research of the best solutions that allows the connection between the panels, keeping the perfect planarity of the outside panel, enhanced with a special aluminum insert developed and patented for PLANA. That's not all: Plana can be highly customized by choosing from the range of the aluminum insert decoration (from 10 to 2 mm thickness) and the several coatings.

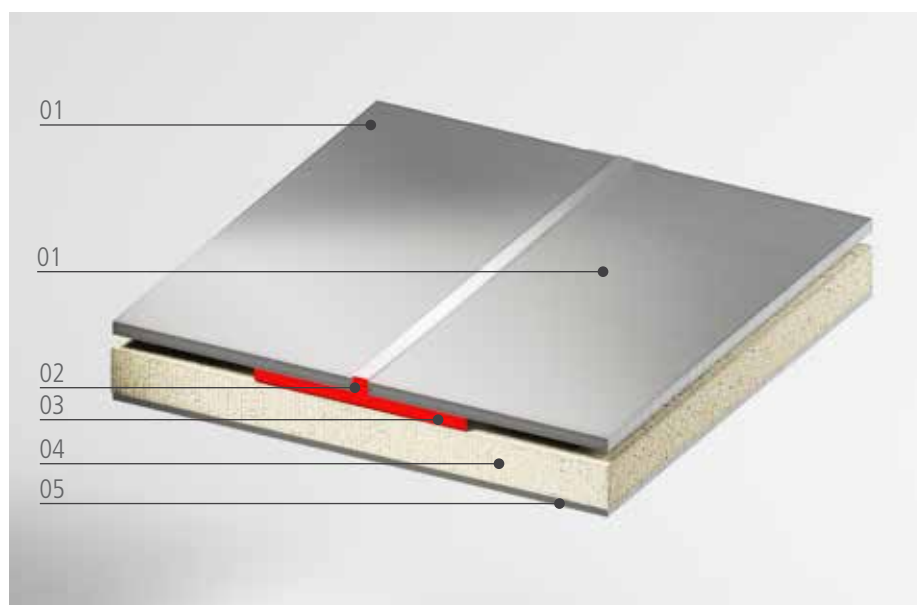
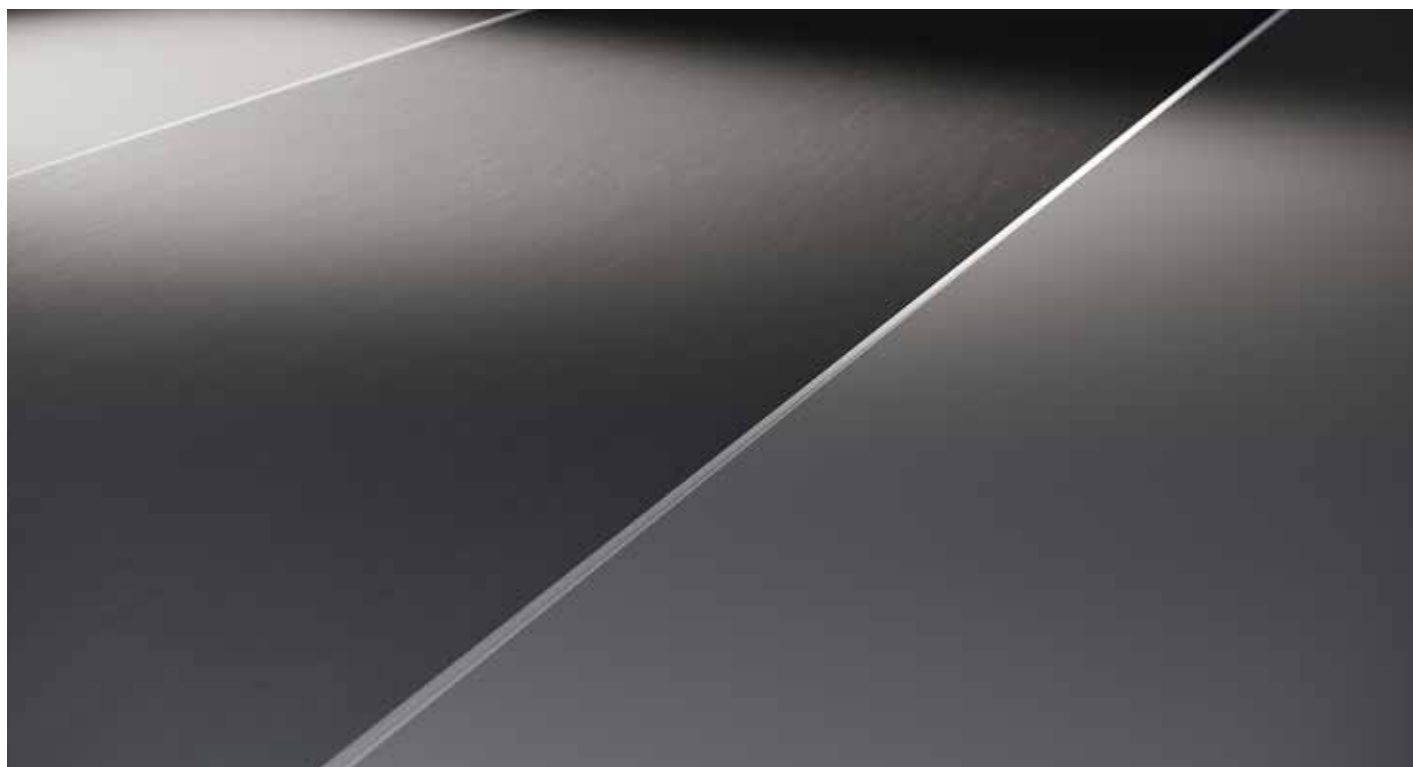

- 01 Lamiera in alluminio 1,2 mm
- 02 Interconnessione lamiera con profilo in alluminio estruso **2 mm** -brevetto.
- 03 Insetto in alluminio
- 04 T.H.S. fibra naturale
- 05 Lamiera in alluminio 0,4 mm

- 01 Aluminum sheet 1,2 mm
- 02 Sheet inter-connection with outline in anodized aluminum (patented system)
- 03 Aluminum insert
- 04 T.H.S. natural fibre
- 05 Aluminum sheet 0,4 mm

Per le finiture disponibili degli inserti da 10 mm vedere pag. 172

## Tipologie Pannelli Plana

Pannelli T.H.F. in Fibra Naturale e Pannelli in H.I. con Doppia Anima / *THF Panels in Natural Fiber and Panels in H.I. with Double Soul*





mm	7 mm	12 mm	15 mm	
INT  <b>T.H.F.</b> Fibra Naturale  EXT				
Kg/m <sup>2</sup>   W/m <sup>2</sup>   dB	9,60   4,94   ndp	12,6   4,37   ndp	15,80   4,16   ndp	
INT  <b>H.I.</b> Doppia Anima  EXT				
Kg/m <sup>2</sup>   W/m <sup>2</sup>   dB				

## H.I. : Il Primo Pannello Con Doppia Anima

Plana è la materializzazione del concetto di innovazione nel mondo dei portoncini d'ingresso: il primo pannello con doppia anima flessibile (versione da 40 mm). Il massimo delle prestazioni: è questo il must che rende Plana unico nel suo genere. Da oggi, infatti, con la nuova tecnologia e l'inserimento della doppia anima flessibile, oltre a migliorare incredibilmente le prestazioni, questo prodotto innovativo sul mercato consente di controllare la dilatazione termica derivante dall'irraggiamento nella parte esterna. Inoltre, grazie all'inserimento della seconda anima flessibile, permette di controllare la dilatazione interna dovuta alla forte escursione termica tra la temperatura interna (ambiente riscaldato) e la temperatura esterna, soprattutto nei periodi invernali e in zone con forte escursione tra giorno e notte.

## Gamma In T.H.F.

La composizione del pannello Plana fa un salto in avanti e presenta un nuovo materiale, il T.H.F. in fibra naturale. Un incredibile risultato di studi e implementazioni tecnologiche che oltre a migliorare i materiali del portoncino Plana, garantisce la massima lavorabilità del prodotto, planarità delle superfici ed incredibile resistenza ed elasticità. Inoltre la composizione in multistrati permette il fissaggio degli accessori in ogni punto del pannello.

	Lamiera in alluminio 1,2 mm / Aluminum sheet 1,2 mm	Kg/m <sup>2</sup> = Peso al Metro Quadro / Weight per Square Meter W/m <sup>2</sup> = Isolamento Termico / Thermal Insulation dB = Isolamento Acustico / Soundproofing INT = Interno / Interior EXT = Esterno / Exterior
	T.H.S. fibra naturale / T.H.S. natural fibre	
	Lamiera in alluminio 0,4 mm / Aluminum sheet 0,4 mm	
	H.I. Anima Flessibile / Flexible core H.I.	
	Poliuretano Isolante HD / Polyurethane non-conducting HD	

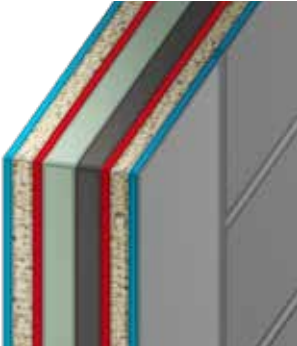
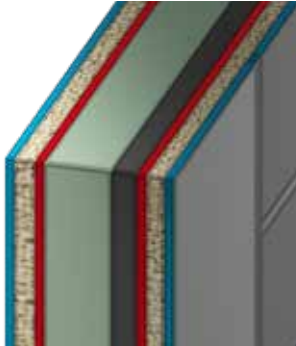
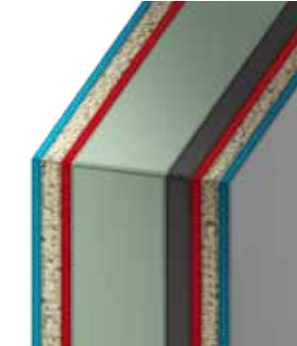
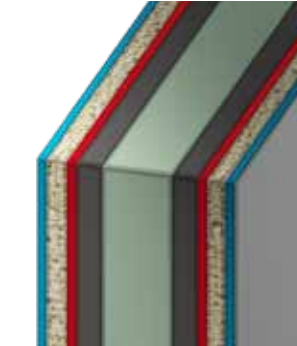
	24 mm	30 mm	35 mm	40 mm
				
	23,50   2,32   ndp	25,50   1,56   ndp	26,50   1,25   ndp	27,50   16,2   ndp

## H.I. : The First Double Core Panel

Plana shows the materialization of the innovation concept in the front-door market. It represents the first double core panel (40 mm thickness) which just gets the best performances: this is the 'MUST' that makes Plana unique on its kind. Its new technology and its flexible double core enhance its own performances and allows a better control of the thermal expansion due to the sunlight irradiation of its outward side. Furthermore, the inward side expansion, due to the thermal difference between outside and inside temperature, mainly during winter time and in particular areas with high day-night temperature excursion, can be controlled thanks to the second flexible core.

## T.H.F. PANEL

Plana's panel composition steps forward and introduces a new material: the natural fiber T.H.F. It represents an outstanding outcome of research and technologic implementations that improves the composition of the Plana doors and guarantees the maximum product workability, the surface planarity and an exceptional strength and flexibility. Moreover the multilayer panel composition grants the full surface availability for accessories installation.

# Collezione Linea

## Pannelli In Alluminio Fresati

La collezione Linea si caratterizza per la lavorazione fresata di 3 mm di spessore su pannelli in alluminio per porte, portoncini e porte blindate. Grazie all'utilizzo di utensili taglienti a geometria definita, questa tecnologia di lavorazione consente di ottenere una vasta gamma di disegni con una precisione estrema, su pannelli in alluminio lavorati con diverse finiture della gamma Ponzio. I disegni sono sempre in continuo aggiornamento e possono essere personalizzati secondo le esigenze del cliente.

*The Linea collection is characterized by a milled processing of 3 mm thickness on aluminum panels used for doors, gates, and armored doors. Thanks to the use of cutting tools with defined geometry, this processing technology allows obtaining a wide range of designs with extreme precision on aluminum panels processed with different finishes from the Ponzio range. The designs are constantly updated and can be customized according to customer needs.*

Ponzio  
pan  
nel  
i

# Collezione Linea Trend / Linea Trend Collection

Pannelli con fresatura da 10mm / Panels with 10mm milling



F3145



F3165



F3175

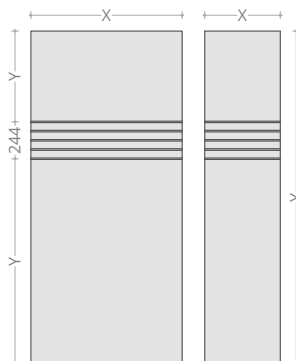

F3145

F3147

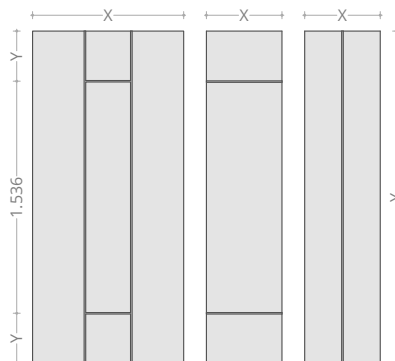

F3165

F3167

F3002

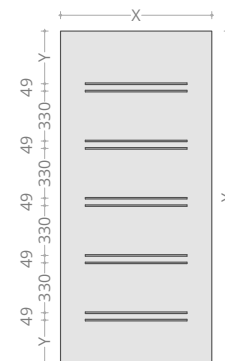

F3175

I disegni sono rappresentati in scala: 1000 mm di base per 2200 mm di altezza ; Y ha valore variabile tra 300 e 900 mm, X ha un valore variabile tra 80 mm e i 160 mm





Modello / Door Model: Lx-Plana 1 Anta  
Finiture / Finishes: Acciaio Chiaro CHACC PolyCrom  
Maniglione / Handle: puntatore BU3588



Modello / Door Model: Lx-Plana 1 Anta  
Finiture / Finishes: Acciaio Chiaro CHACC PolyCrom  
Maniglione / Handle: puntatore BU3588



# Collezione Linea Trend / Linea Trend Collection

Pannelli con fresatura da 10mm / Panels with 10mm milling



F3170



F3171



F3185

Bronzo 32 EXBR32 Technologies

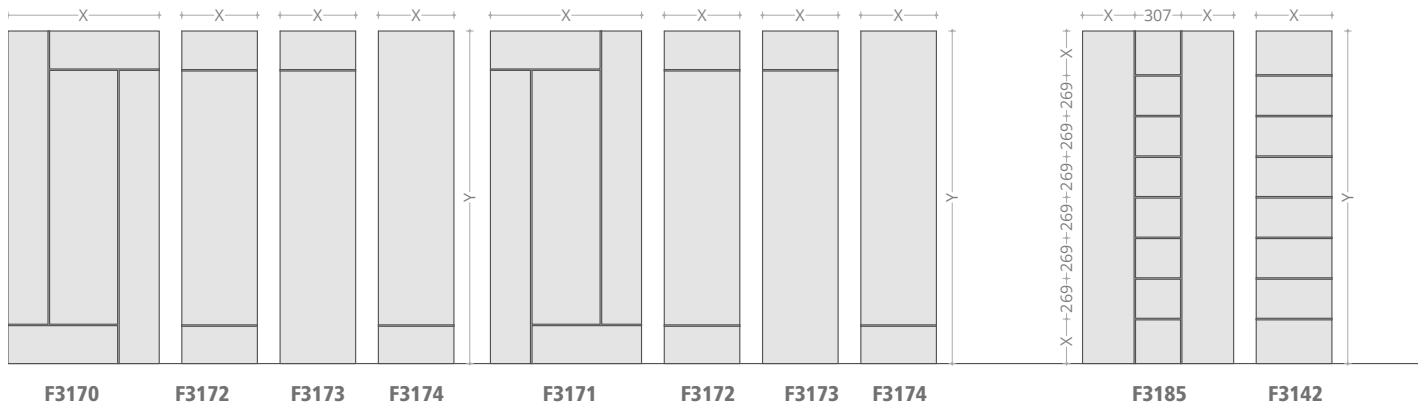

I disegni sono rappresentati in scala: 1000 mm di base per 2200 mm di altezza ; Y ha valore variabile tra 300 e 900 mm, X ha un valore variabile tra 80 mm e i 160 mm



F3115



F3151



F3160

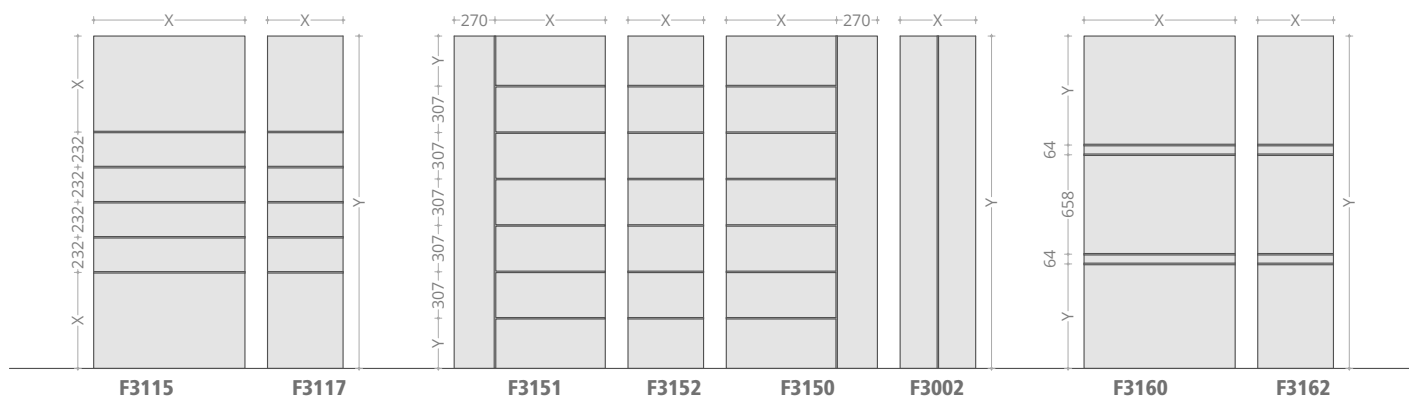

I disegni sono rappresentati in scala: 1000 mm di base per 2200 mm di altezza ; Y ha valore variabile tra 300 e 900 mm, X ha un valore variabile tra 80 mm e i 160 mm

# Collezione Linea Trend / Linea Trend Collection

Pannelli con fresatura da 10mm / Panels with 10mm milling



F3100



F3110



F3010

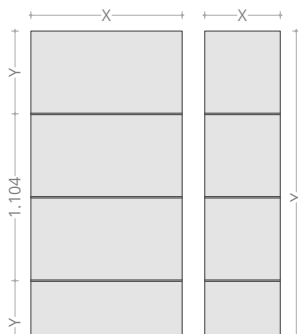

F3100

F3102

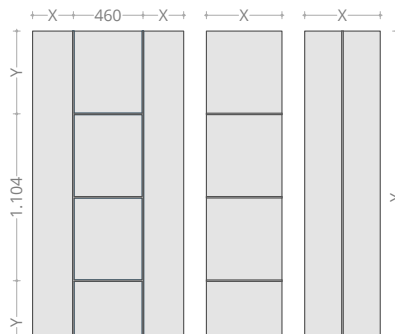

F3110

F3102

F3002

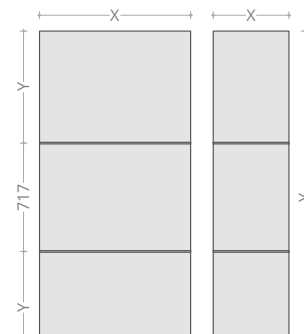

F3010

F3012

I disegni sono rappresentati in scala: 1000 mm di base per 2200 mm di altezza ; Y ha valore variabile tra 300 e 900 mm, X ha un valore variabile tra 80 mm e i 160 mm

Modello / Door Model: Lx-Plana 1 Anta  
Finiture / Finishes: Sabbia 32 EXSN Technologies  
Maniglione / Handle: Letizia - BU890134

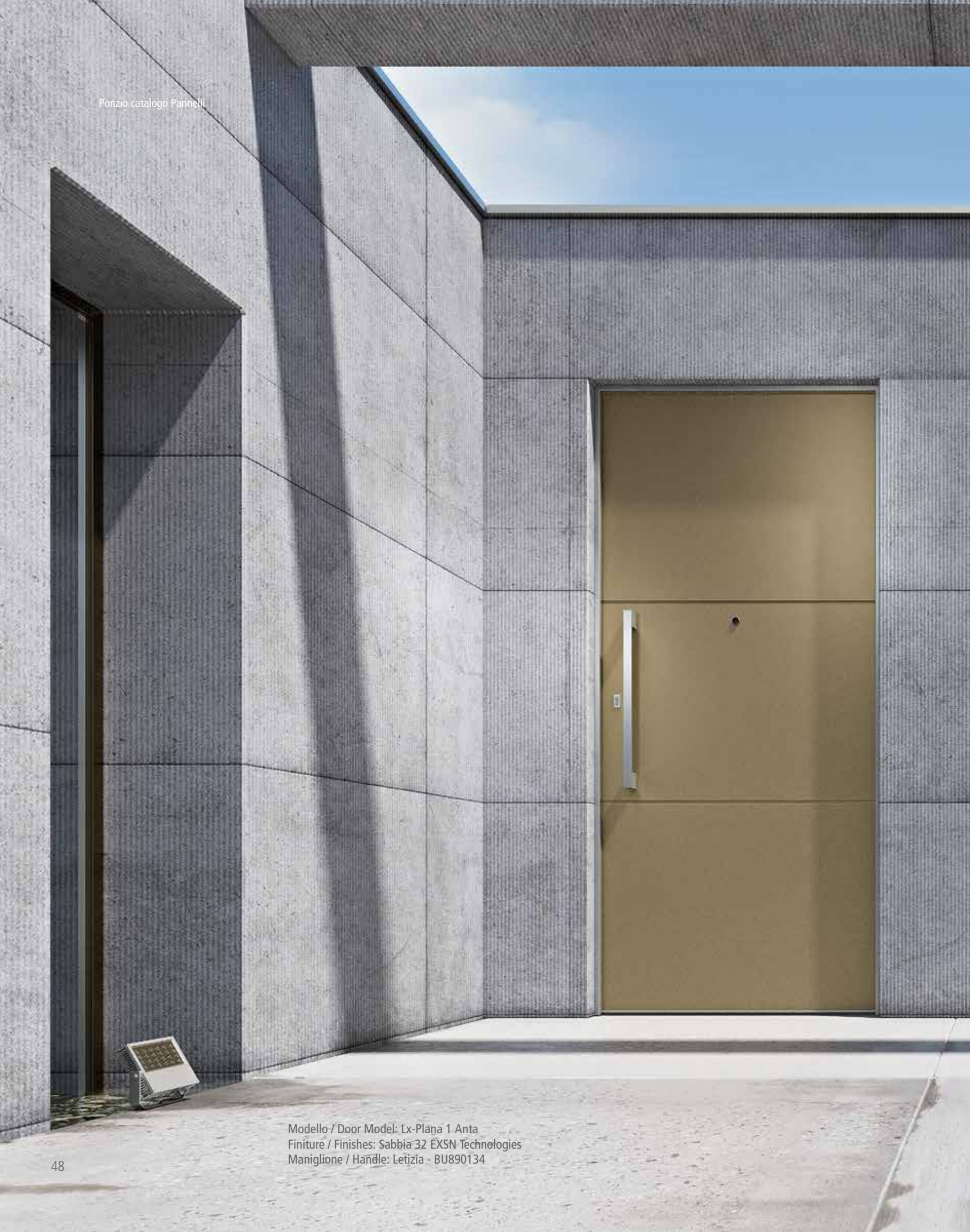

Modello / Door Model: Lx-Plana 1 Anta  
Finiture / Finishes: Sabbia 32 EXSN Technologies  
Maniglione / Handle: Letizia - BU890134





# Collezione Linea Trend / Linea Trend Collection

Pannelli con fresatura da 10mm / Panels with 10mm milling



F3125



F3130



F3135

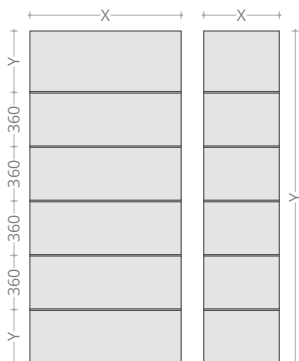

F3125

F3127

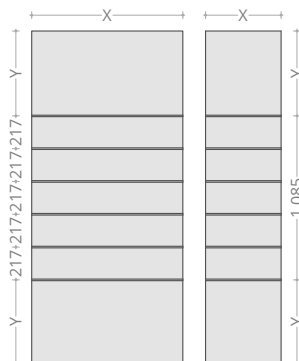

F3130

F3132

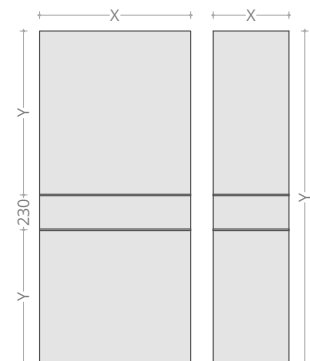

F3135

F3137

I disegni sono rappresentati in scala: 1000 mm di base per 2200 mm di altezza ; Y ha valore variabile tra 300 e 900mm, X ha un valore variabile tra 80 mm e i 160 mm



F3155



F3120

Verde Micaceo MIVER Polycrom



F3140

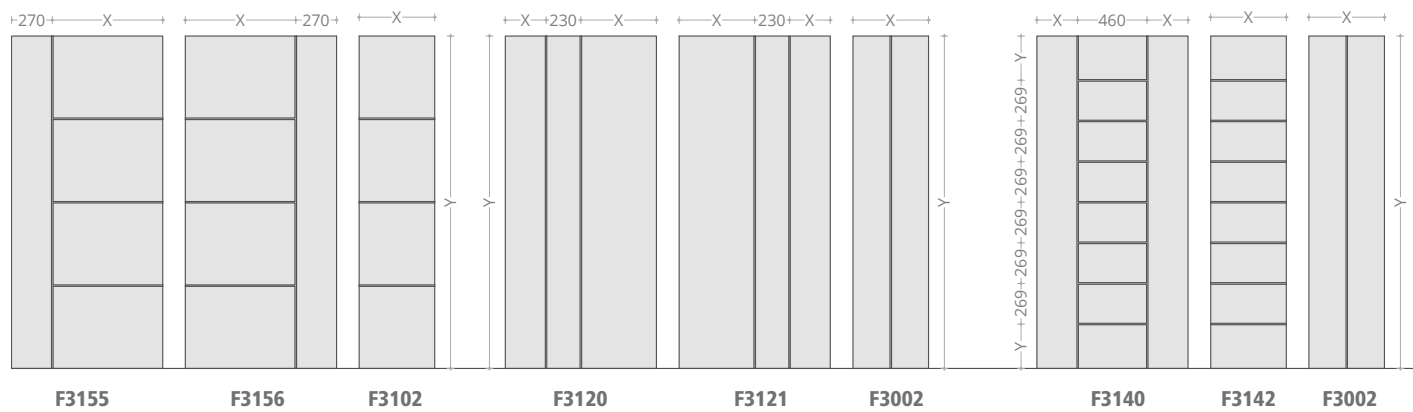

I disegni sono rappresentati in scala: 1000 mm di base per 2200 mm di altezza ;  $Y$  ha valore variabile tra 300 e 900 mm,  $X$  ha un valore variabile tra 80 mm e 160 mm

# Collezione Linea Tech / Linea Tech Collection

Pannelli con fresatura da 10mm / Panels with 10mm milling



F3105



F3000



F3015

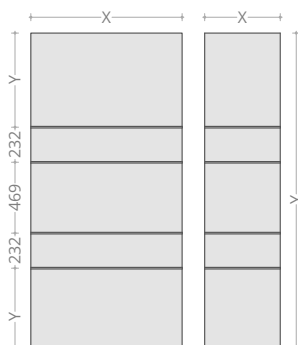

F3105

F3107

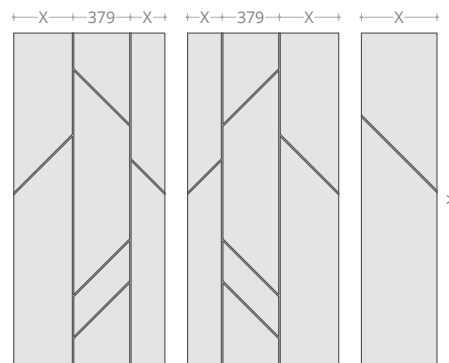

F3000

F3001

F3003

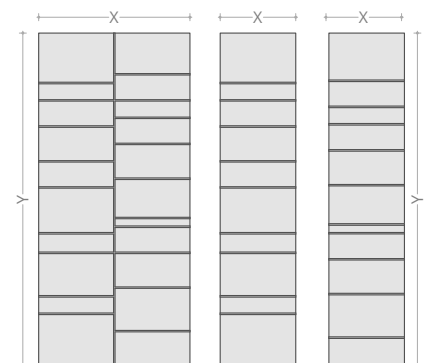

F3015

F3017

F3018

I disegni sono rappresentati in scala: 1000 mm di base per 2200 mm di altezza ; Y ha valore variabile tra 300 e 900 mm, X ha un valore variabile tra 80 mm e 160 mm



Modello / Door Model: lx-Plana 1 Anta con soglia termica  
Finiture / Finishes: Verniciato K8004  
Maniglione / Handle: Mitica - BU890074



Modello / Door Model: Lx-Plana 1 Anta / con soglia termica  
Finiture / Finishes: Verniciato K8004  
Maniglione / Handle: Mitica - BU890074

# Collezione Linea Tech / Linea Tech Collection

Pannelli con fresatura da 10mm / Panels with 10mm milling



F3025



F3020



F3005

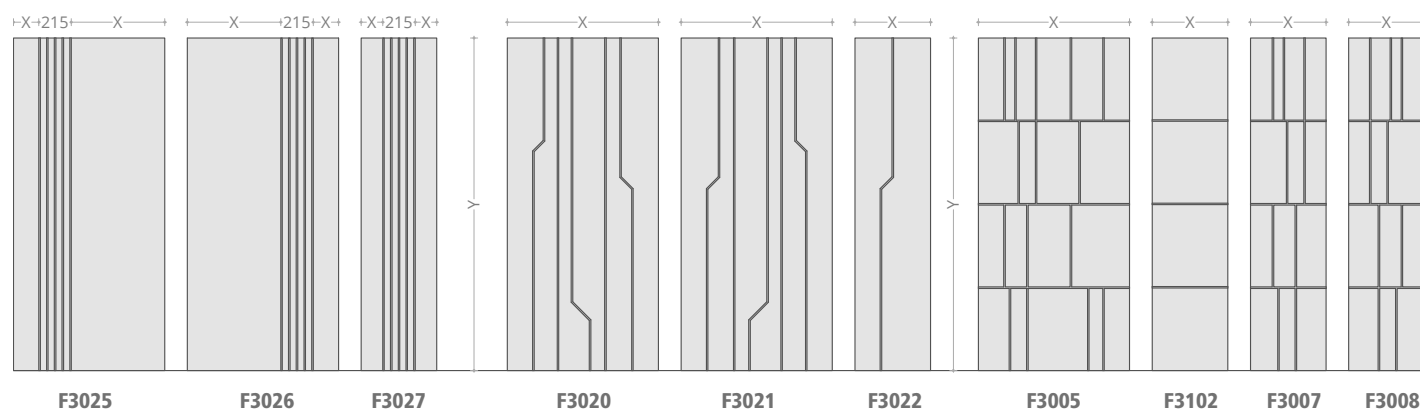

I disegni sono rappresentati in scala: 1000 mm di base per 2200 mm di altezza ;  $Y$  ha valore variabile tra 300 e 900 mm,  $X$  ha un valore variabile tra 80 mm e i 160 mm

# Collezione Linea Geo / Linea Geo Collection

Pannelli con fresatura da 10mm / Panels with 10mm milling



F3040



F3030



F3045

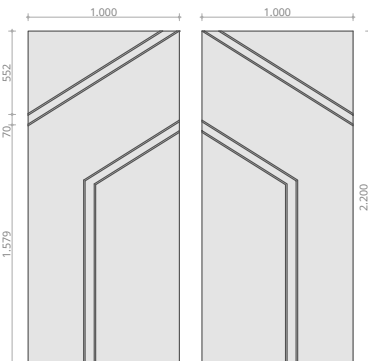

F3040

F3041

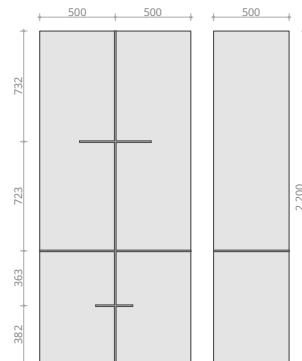

F3030

F3032

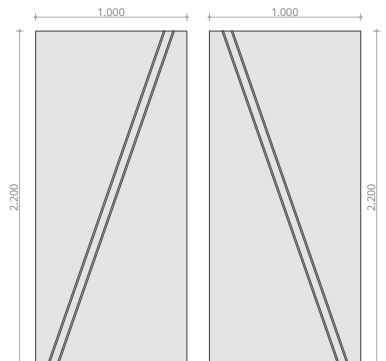

F3045

F3046

I disegni sono rappresentati in scala: 1000 mm di base per 2200 mm di altezza ; *Y* ha valore variabile tra 300 e 900 mm, *X* ha un valore variabile tra 80 mm e i 160 mm



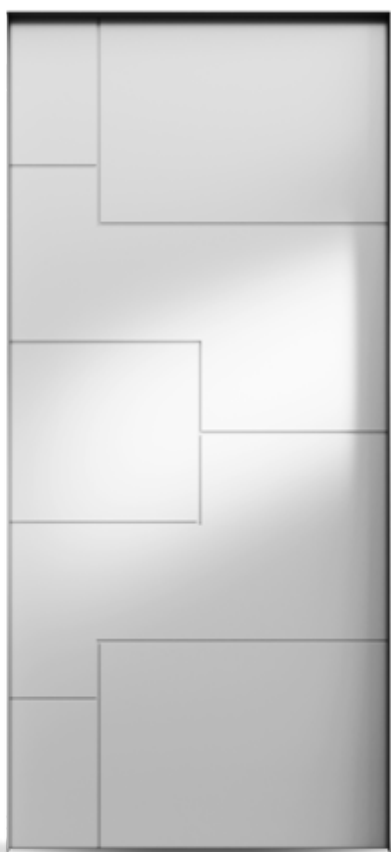

F3050



F3035



F3055

Acciaio Chiaro CHACC Polycrom

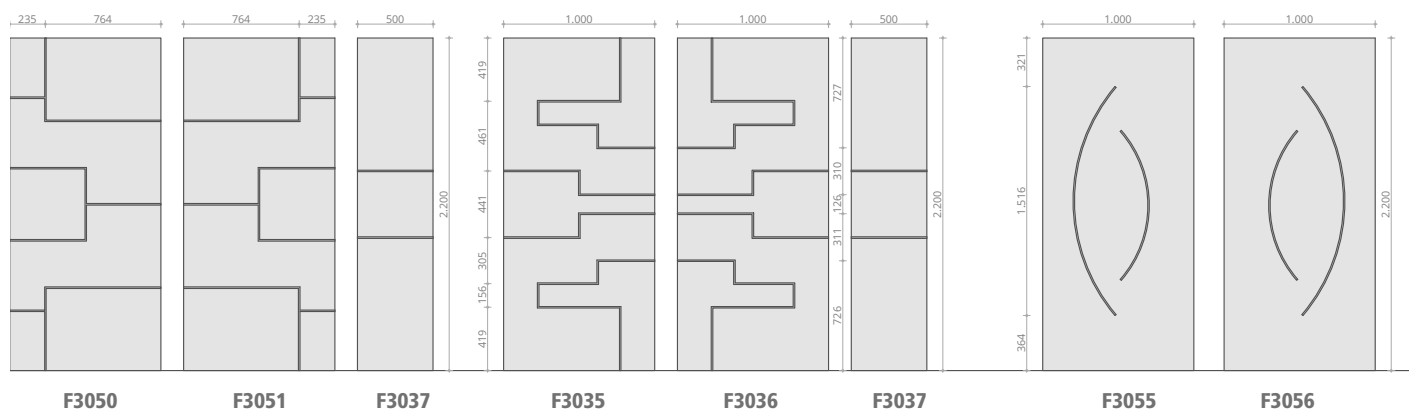

I disegni sono rappresentati in scala: 1000 mm di base per 2200 mm di altezza ; Y ha valore variabile tra 300 e 900 mm, X ha un valore variabile tra 80 mm e i 160 mm

# Collezione Linea Light / Linea Light Collection

Pannelli con fresatura da 10mm / Panels with 10mm milling



F3060



F3065



F3070

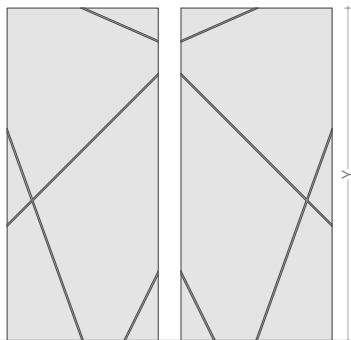

F3060

F3061

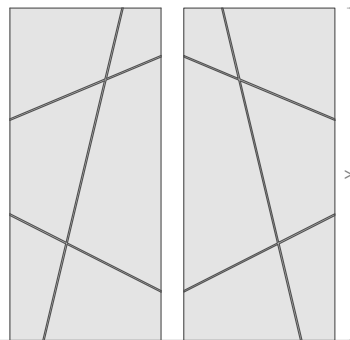

F3065

F3066

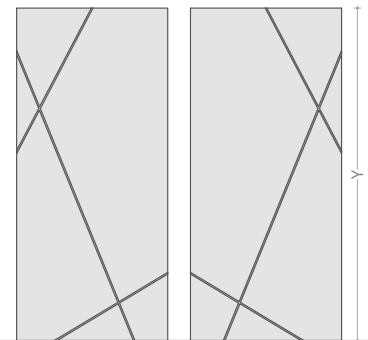

F3070

F3071

I disegni sono rappresentati in scala: 1000 mm di base per 2200 mm di altezza ; Y ha valore variabile tra 300 e 900 mm, X ha un valore variabile tra 80 mm e i 160 mm



Modello / Door Model: Ponzio Bilico  
Finiture / Finishes: Cobalto Brillante 11  
Maniglione / Handle: Fashion - BU3608

## Collezione Linea Light / Linea Light Collection

Pannelli con fresatura da 10mm / Panels with 10mm milling



F3075



F3080



F3085

Zolfo Normal VEZNR Velvet

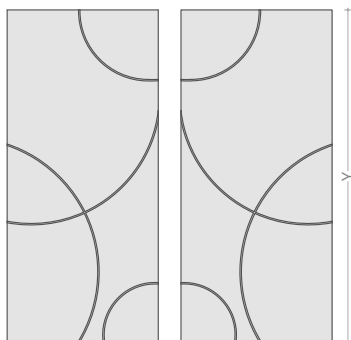

F3075

F3076

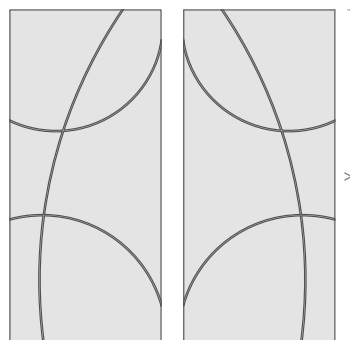

F3080

F3081

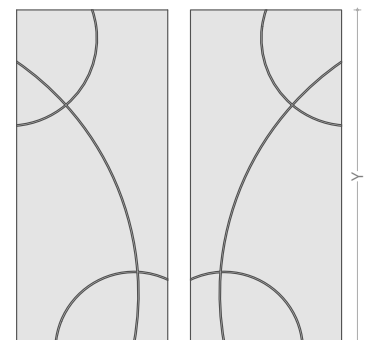

F3085

F3086

I disegni sono rappresentati in scala: 1000 mm di base per 2200 mm di altezza ; Y ha valore variabile tra 300 e 900 mm, X ha un valore variabile tra 80 mm e i 160 mm



F3097

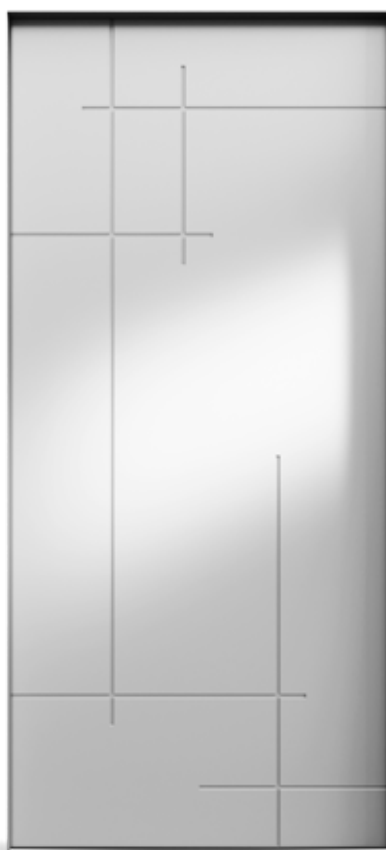

F3090



F3095

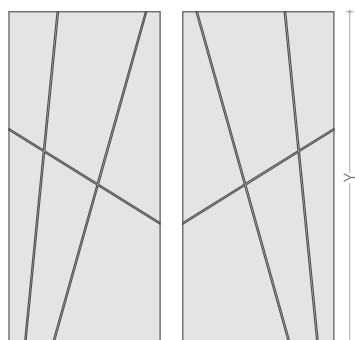

F3097

F3098

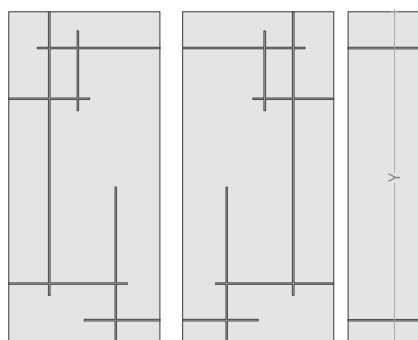

F3090

F3091

F3092

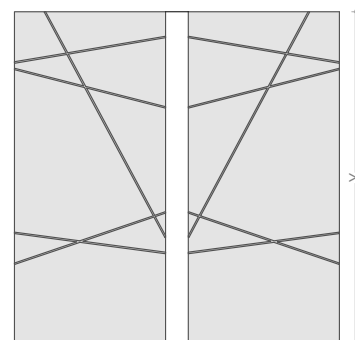

F3095

F3096

I disegni sono rappresentati in scala: 1000 mm di base per 2200 mm di altezza ; Y ha valore variabile tra 300 e 900 mm, X ha un valore variabile tra 80 mm e i 160 mm

# Collezione Linea Inserti

## Pannelli In Alluminio Fresati Con Inserti

La collezione Linea Inserti offre pannelli in alluminio per porte, portoncini e porte blindate con una lavorazione fresata di 3 mm di spessore, che permette di ottenere disegni precisi e anche personalizzabili con l'aggiunta di inserti in alluminio che conferiscono una maggiore eleganza e preziosità ai pannelli, mettendo ancora di più in risalto il disegno e la geometria del pannello.

*The Linea Inserti collection offers aluminum panels for doors, gates, and armored doors with a 3 mm thick milling processing that allows obtaining precise designs that can be customized with the addition of aluminum inserts, giving the panels more elegance and value, highlighting even more the design and geometry of the panel.*

Ponzio  
van  
nel  
i



# Collezione Linea Inserti / Insert Linea Collection

Pannelli con fresatura e inserti da 10mm / Panels with milling and 10mm inserts



F3270



F3250



F3285

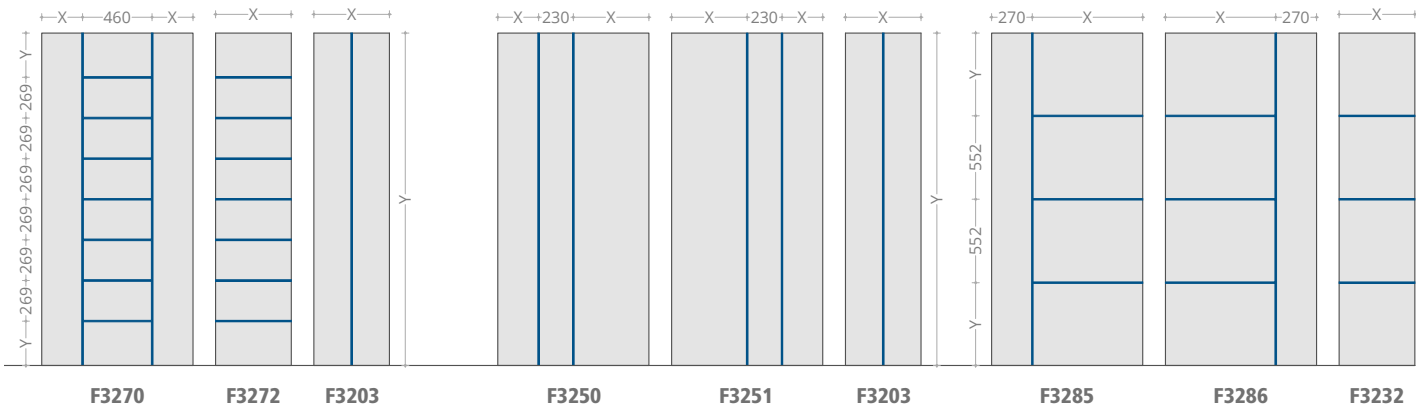

Inserto in alluminio

I disegni sono rappresentati in scala: 1000 mm di base per 2200 mm di altezza ; *Y* ha valore variabile tra 300 e 900 mm, *X* ha un valore variabile tra 80 mm e i 160 mm





Modello / Door Model: Lx-Linea 1 Anta + 1 Anta Asimmetrica con soglia termica  
Finiture / Finishes: Bianco Grinz GRIBI Polycrom  
Maniglione / Handle: Mitica - BU890064

# Pannelli Linea Inserti

## Straordinariamente Unici



Modello / Door Model: Lx-Linea 1 Anta + 1 Anta Asimmetrica con soglia termica  
Finiture / Finishes: Bianco Grinz GRIBI Polycrom  
Maniglione / Handle: Mitica - BU890064

# Collezione Linea Inserti / Insert Linea Collection

Pannelli con fresatura e inserti da 10mm / Panels with milling and 10mm inserts



F3230



F3200

Verona MBVR11 Marble



F3235

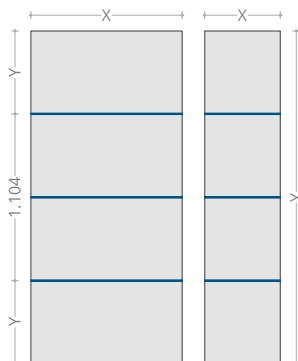

F3230

F3232

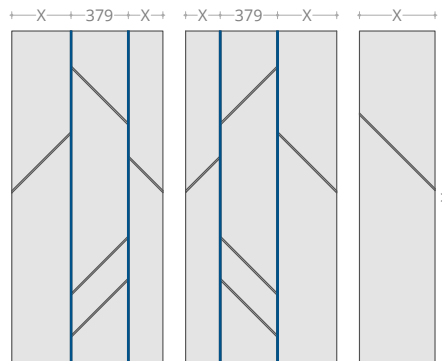

F3200

F3201

F3003

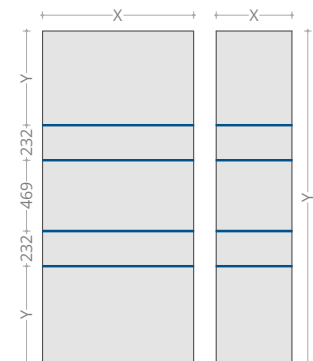

F3235

F3237

 Inserto in alluminio

I disegni sono rappresentati in scala: 1000 mm di base per 2200 mm di altezza ; Y ha valore variabile tra 300 e 900 mm, X ha un valore variabile tra 80 mm e i 160 mm



F3255



F3260



F3265

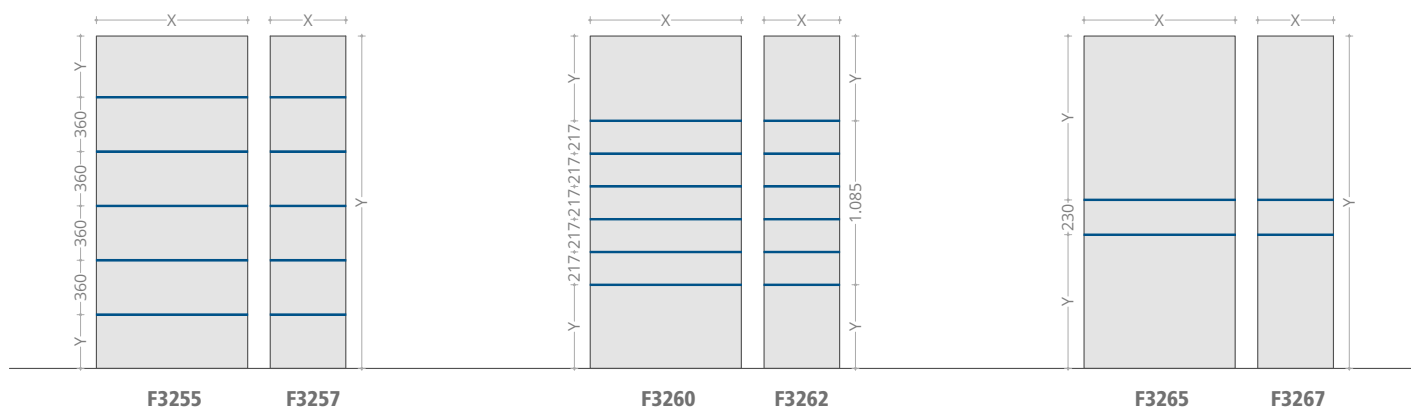

I disegni sono rappresentati in scala: 1000 mm di base per 2200 mm di altezza ; Y ha valore variabile tra 300 e 900 mm, X ha un valore variabile tra 80 mm e i 160 mm

# Collezione Linea Inserti / Insert Linea Collection

Pannelli con fresatura e inserti da 10mm / Panels with milling and 10mm inserts



F3452



F3295



F3220

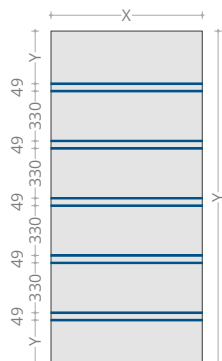

F3452

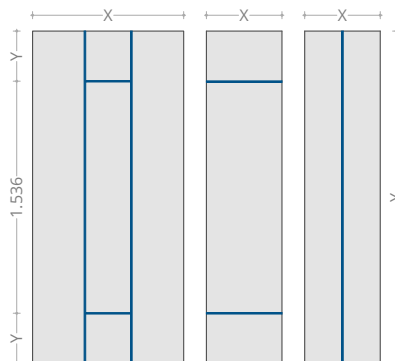

F3295

F3297

F3203

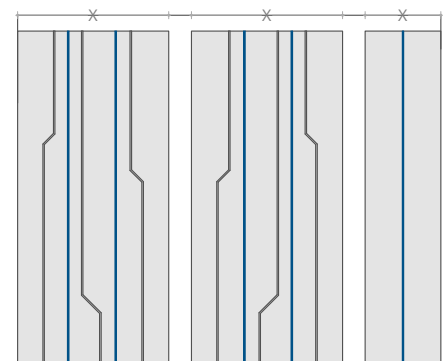

F3220

F3221

F3203

 Inserto in alluminio

I disegni sono rappresentati in scala: 1000 mm di base per 2200 mm di altezza ; Y ha valore variabile tra 300 e 900 mm, X ha un valore variabile tra 80 mm e i 160 mm



Modello / Door Model: Lx-Linea 2 Ante Asimmetriche  
Finiture / Finishes: BLu Elegante Normal VEBENR Velvet  
Maniglione / Handle: Letizia - BU890134

## Collezione Linea Inserti / Insert Linea Collection

Pannelli con fresatura e inserti da 10mm / Panels with milling and 10mm inserts



F3300



F3301



F3310

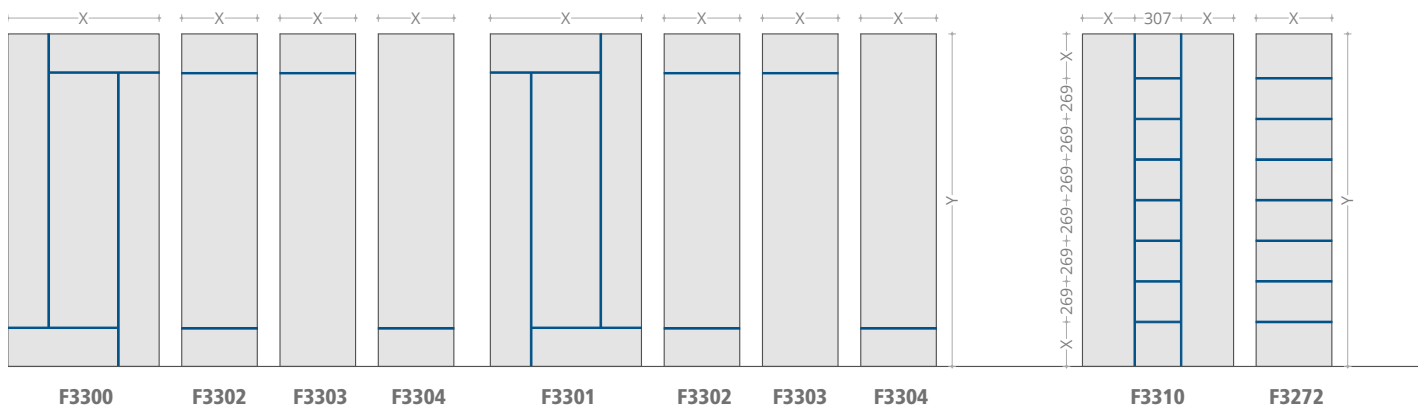

F3300

F3302

F3303

F3304

F3301

F3302

F3303

F3304

F3310

F3272

 Inserto in alluminio

I disegni sono rappresentati in scala: 1000 mm di base per 2200 mm di altezza ; *Y* ha valore variabile tra 300 e 900 mm, *X* ha un valore variabile tra 80 mm e i 160 mm





F3245



F3281



F3275

Bronzo Scuro Spazzolato QXBRSC Anodize

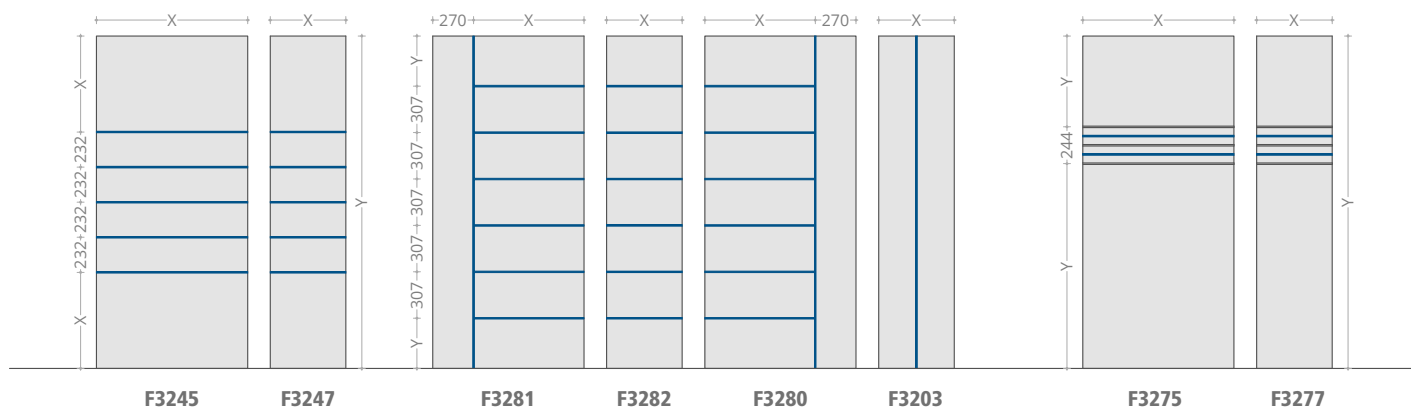

I disegni sono rappresentati in scala: 1000 mm di base per 2200 mm di altezza ;  $Y$  ha valore variabile tra 300 e 900 mm,  $X$  ha un valore variabile tra 80 mm e i 160 mm



Modello / Door Model: Ponzio Bilico  
Finiture / Finishes: Shark 11 THSH11 Soft Touch  
Maniglione / Handle: Fashion - BU3608 Inox AISI 316L

# Collezione Linea Inserti / Insert Linea Collection

Pannelli con fresatura e inserti da 10mm / Panels with milling and 10mm inserts



F3290



F3205



F3225

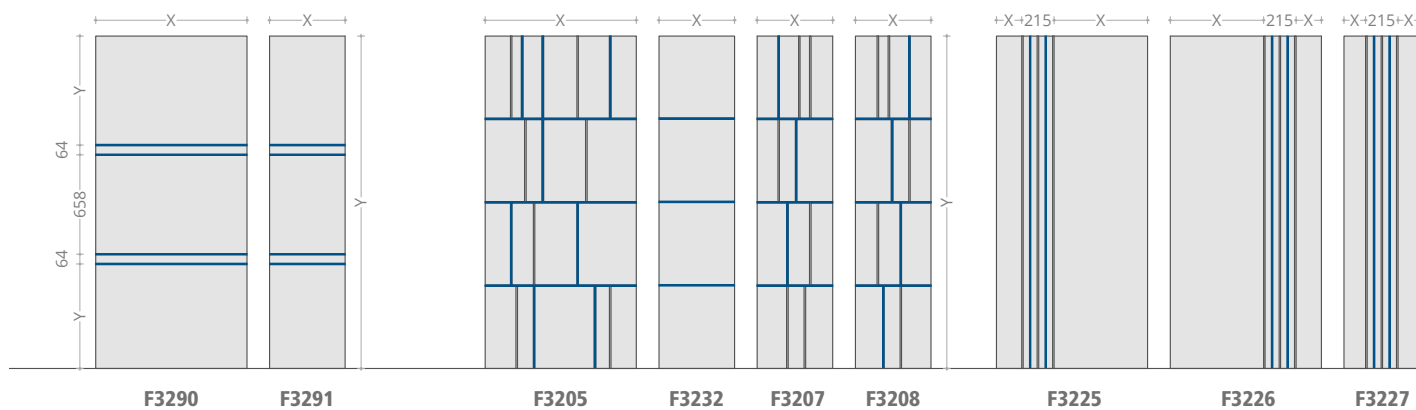

 Inserto in alluminio

I disegni sono rappresentati in scala: 1000 mm di base per 2200 mm di altezza ;  $Y$  ha valore variabile tra 300 e 900 mm,  $X$  ha un valore variabile tra 80 mm e 160 mm





Modello / Door Model: Ponzio Bilico  
Finiture / Finishes: Shark 11 THSH11 Soft Touch  
Maniglione / Handle: Fashion - BU3608 Inox AISI 316L

# Collezione Linea Inserti / Insert Linea Collection

Pannelli con fresatura e inserti da 10mm / Panels with milling and 10mm inserts



F3230



F3240



F3215

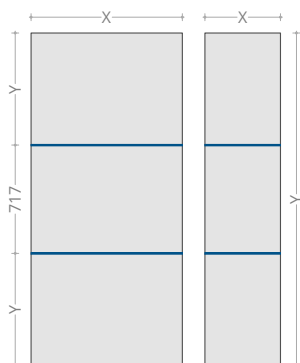

F3230

F3232

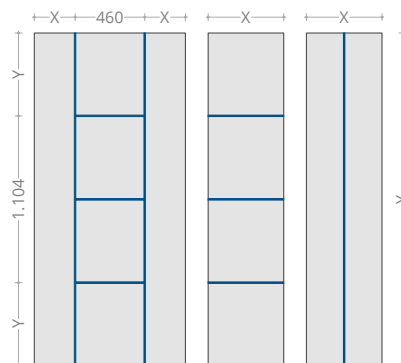

F3240

F3232

F3203

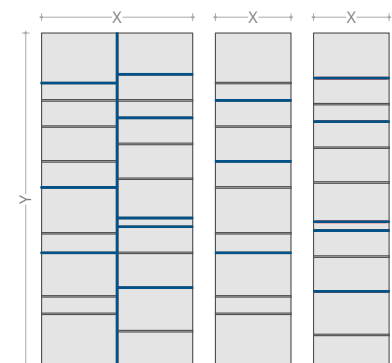

F3215

F3217

F3218

Inserto in alluminio

I disegni sono rappresentati in scala: 1000 mm di base per 2200 mm di altezza ; Y ha valore variabile tra 300 e 900 mm, X ha un valore variabile tra 80 mm e i 160 mm



Modello / Door Model: Lx-Linea 1 Anta  
Finiture / Finishes: Kaki Sand MBKA11 Marbel  
Maniglione / Handle: Magnetic - BU3678





Modello / Door Model: Lx-Linea 1 Anta  
Finiture / Finishes: Kaki Sand MBKA11 Marbel  
Maniglione / Handle: Magnetic - BU3678

## Fresatura 10 mm Linea

Inserto in alluminio per collezione Planaa

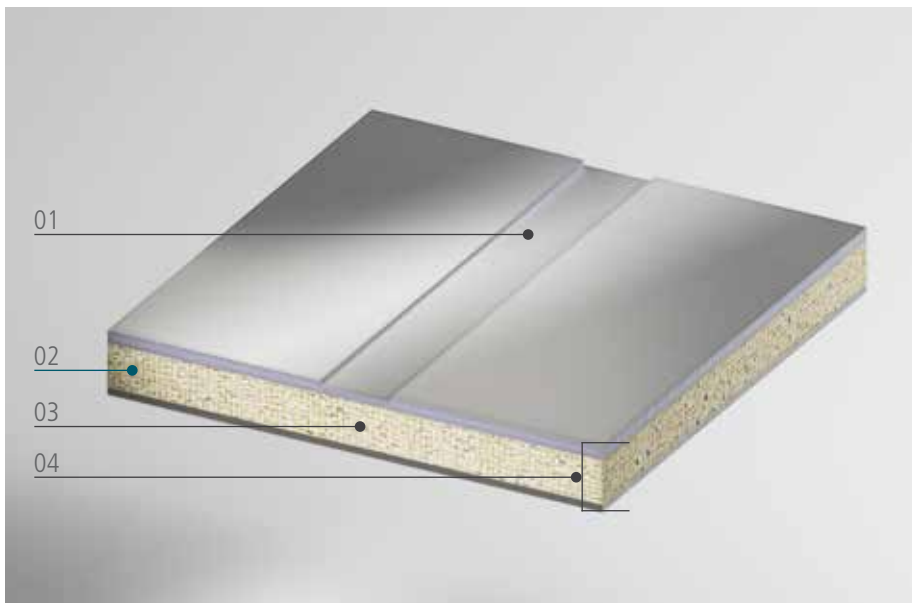

- 01 Lamiera in alluminio fresata da 3mm
- 02 Lamiera in alluminio da 0,5mm
- 03 Membrana termoacustica
- 04 Totale spessore pannello 7mm

- 01 Milled aluminum sheet 3mm thick*
- 02 Aluminum sheet 0.5mm thick*
- 03 Thermal and acoustic membrane*
- 04 Total panel thickness 7mm*

Per le finiture disponibili degli inserti da 10 mm vedere pag. 172

## Fresatura 10 mm Linea Inserti

Inserto in alluminio per collezione Plana

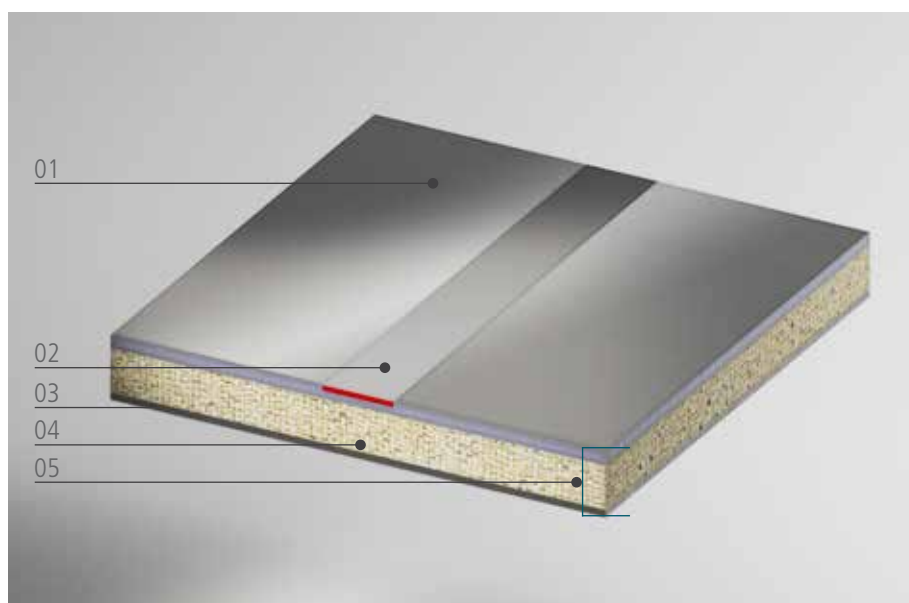

- 01 Lamiera in alluminio fresata da 3mm
- 02 Inserto in alluminio
- 03 Lamiera in alluminio da 0,5mm
- 04 Membrana termoacustica
- 05 Totale spessore pannello 7mm

- 01 3mm Milled Aluminum Sheet*
- 02 Aluminum Insert*
- 03 0.5mm Aluminum Sheet*
- 04 Thermoacoustic Membrane*
- 05 Total Panel Thickness 7mm.*

Per le finiture disponibili degli inserti da 10 mm vedere pag. 172

# Collezione Linea Vetro

## Pannelli In Alluminio Fresati Con Vetro

Scopri la nuova collezione di pannelli in alluminio con parti vetrate per portoncini di Ponzio. L'alluminio si unisce al vetro in diverse colorazioni, finiture e decori per creare un pannello per portoncini elegante e prezioso, unico nel suo genere.

*Discover the new collection of aluminum panels with glass parts for Ponzio doors. Aluminum combines with glass in various colors, finishes, and decorations to create a unique, elegant, and precious door panel.*

**Ponzio**  
pan  
nel  
i

# Collezione Linea Vetro / Glass Line Collection

Pannelli con fresatura e parti vetrate / Panels with milling and glazed parts



F3425



F3460



F3435

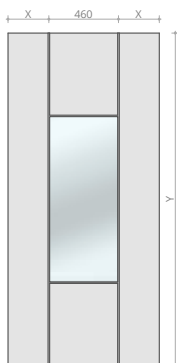

F3425

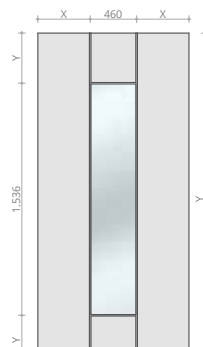

F3460

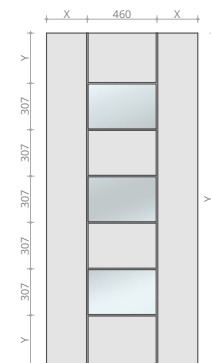

F3435

I disegni sono rappresentati in scala: 1000 mm di base per 2200 mm di altezza ; *Y* ha valore variabile tra 300 e 900 mm, *X* ha un valore variabile tra 80 mm e 160 mm



Modello / Door Model: Lx-Linea Vetro 1 Anta  
Finiture / Finishes: Jaguar 11 Soft Touch  
Maniglione / Handle: Gloria - BU890084







Modello / Door Model: Lx-Linea Vetro 1 Anta  
Finiture / Finishes: Jaguar 11 Soft Touch  
Maniglione / Handle: Gloria - BU890084

# Collezione Linea Vetro / Glass Line Collection

Pannelli con fresatura e parti vetrate / Panels with milling and glazed parts



F3455

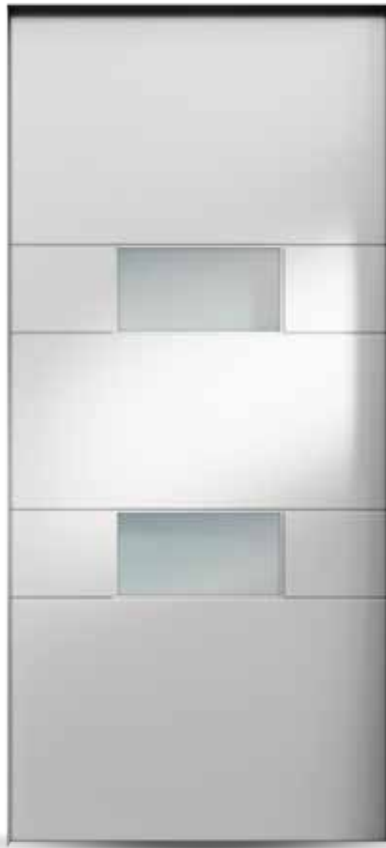

F3420



F3430

Terra Di Siena 11 MBTS11 Marbel

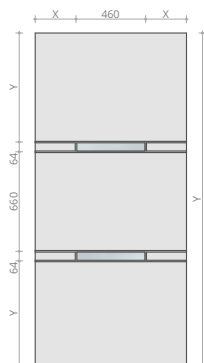

F3455

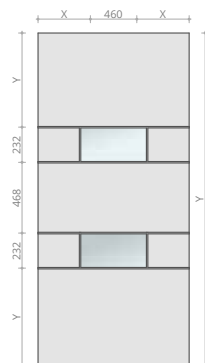

F3420

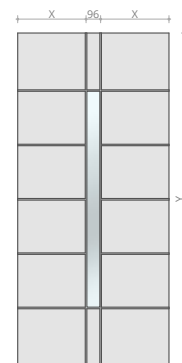

F3430

I disegni sono rappresentati in scala: 1000 mm di base per 2200 mm di altezza ; Y ha valore variabile tra 300 e 900 mm, X ha un valore variabile tra 80 mm e 160 mm



F3440



F3445



F3450

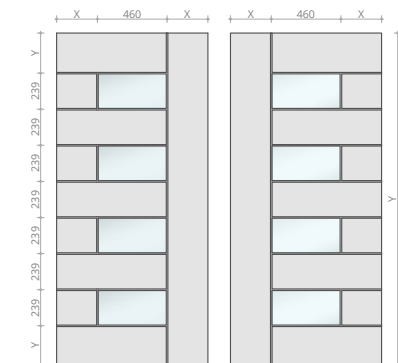

F3440

F3441

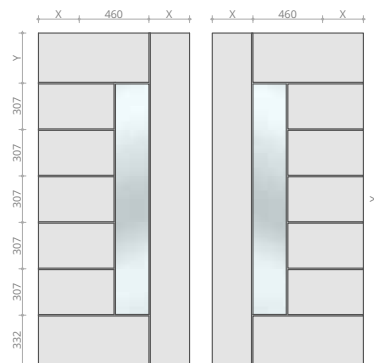

F3445

F3446

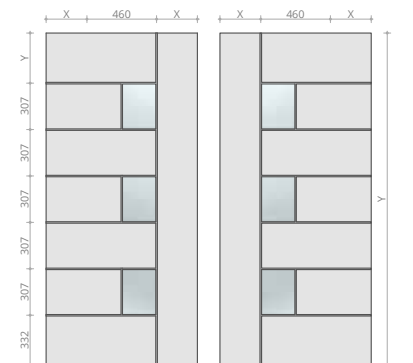

F3450

F3451

I disegni sono rappresentati in scala: 1000 mm di base per 2200 mm di altezza ; *Y* ha valore variabile tra 300 e 900 mm, *X* ha un valore variabile tra 80 mm e i 160 mm

# Collezione Linea Vetro / Glass Line Collection

Pannelli con fresatura e parti vetrate / Panels with milling and glazed parts



F3405



F3415



F3400

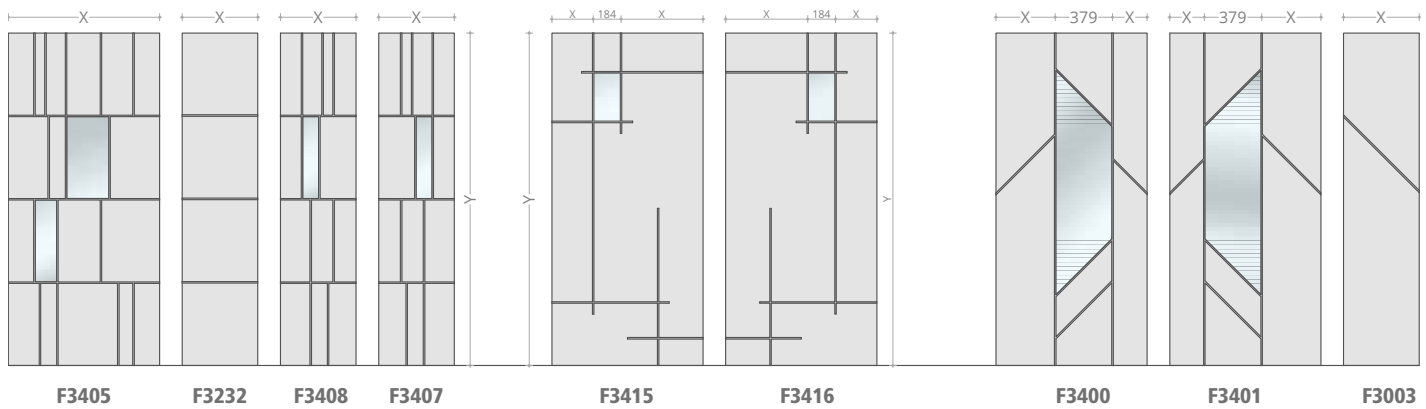

I disegni sono rappresentati in scala: 1000 mm di base per 2200 mm di altezza ;  $Y$  ha valore variabile tra 300 e 900mm,  $X$  ha un valore variabile tra 80 mm e i 160 mm





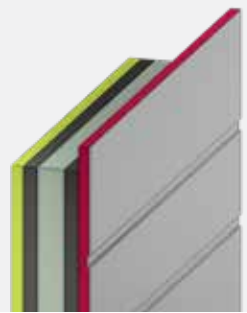
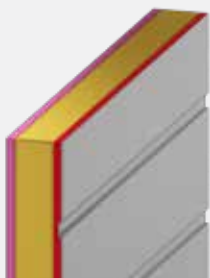
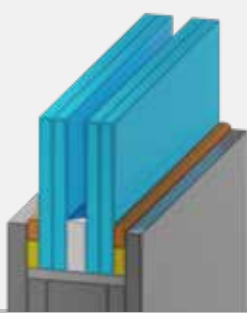

Modello / Door Model: Lx-Linea Vetro 1 Anta  
Finiture / Finishes: Blu Elegance Normal VEBENR Velvet  
Maniglione / Handle: Mitica - BU890064

## Tipologie Pannelli Linea



Modello A, modello B, porta blindata, gamma vetri

Spessore Pannello in mm	7 mm	48 mm	
<p>INT</p> <h3>Modello A</h3> <p>La lamiera esterna é incollata sul profilo anta utilizzando il kit in dotazione.</p> <p><i>The external sheet is glued to the door profile using the supplied kit</i></p> <p>EXT</p>		<p>INT</p>  <p>EXT</p>	
<p>INT</p> <h3>Modello B</h3> <p>La lamiera interna é incollata sul profilo anta, la lamiera esterna deve essere incollata sia sul profilo anta che sul pannello isolante esterno utilizzando il kit in dotazione.</p> <p><i>The internal sheet metal is glued to the leaf profile, the external sheet metal must be glued both to the leaf profile and to the external insulating panel using the supplied kit.</i></p> <p>EXT</p>			
<p>INT</p> <h3>Pannello per Porta blindata</h3> <p>EXT</p>	<p>INT</p>  <p>EXT</p>		
<h3>Gamma vetri</h3>			
Gamma Vetri : W/m <sup>2</sup> K   W/mK		Gamma vetri : 0.66 W/m <sup>2</sup> K   0.015 W/mK	

#### Modello A e modello B / Model A and Model B:

-  Lamiera interna alluminio 2 mm / Internal aluminum sheet 2 mm
-  Membrana Flessibile / Flexible membrane
-  Isolante poliuretano / polyurethane insulation
-  Lamiera ext alluminio fresata 3 mm / 3 mm milled aluminum sheet

#### Pannello per porta blindata / Security door:

-  Lamiera alluminio 0,5 mm / 0.5 mm aluminum sheet
-  Membrana termo acustica / Thermoacoustic membrane
-  Lamiera ext alluminio fresata 3 mm / 3 mm milled aluminum sheet



# Collezione Bugnati

## Pannelli In Alluminio Pressopiegati

Bugnati è la linea di pannelli in alluminio di Ponzio, caratterizzata da un design raffinato e contemporaneo, che si ispira alla tradizione. Grazie alla tecnologia Ponzio, l'alluminio diventa un materiale durevole e resistente, creando un pannello per portoncini dallo stile classico senza tempo.

*Bugnati is the aluminum panel collection from Ponzio with a refined and prominent design inspired by tradition but also modern. Thanks to Ponzio technology, aluminum becomes a timeless and durable classic-style panel for doors that is also resistant.*



Ponzio  
pan  
nel  
i

# Collezione Bugnati / Bugnati Collection

Pannelli pressopiegati in alluminio / Aluminum press bent panels



Crystal 0536



Oxford 0530



Aston 0301

K1023 Verniciato RAL

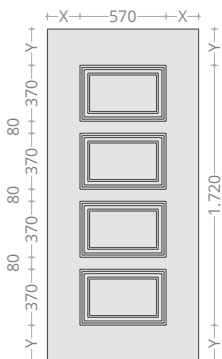

Crystal 0536

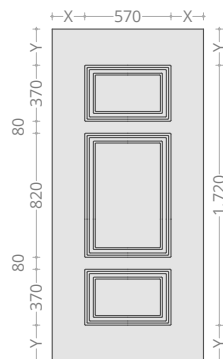

Oxford 0530

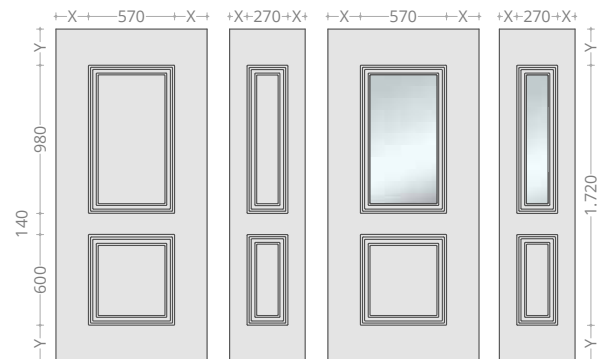

Aston 0301

Aston 0311

Aston 0305

Aston 0315

I disegni sono rappresentati in scala: 1000 mm di base per 2200 mm di altezza ; Y ha valore variabile tra 300 e 900 mm, X ha un valore variabile tra 80 mm e i 160 mm



Modello / Door Model: Lx-Bugnati 1 Anta  
Finiture / Finishes: K1023 Verniciato RAL  
Maniglione / Handle: Diva - BU890104

Ponizio catalogo Pannelli

# Pannelli Bugnati

## Straordinariamente Unici



**Ponizio**  
Aluminium design since 1941

Modello / Door Model: Lx-Bugnati 1 Anta  
Finiture / Finishes: K1023 Verniciato RAL  
Maniglione / Handle: Diva - BU890104



## **Possibili Varianti Finiture / *Possible Variants Finishes***

Per ogni modello molteplici combinazioni di finiture, colori e inserti / *For each model multiple combinations of finishes, colors and inserts*



**Aston 0301**



Aston 0311 + Aston 0301

Finitura / Finishes:



Verde Bosco 11  
Marbel

Maniglione / Handle:



Venere - Cromo Satinato



Aston 0315 + Aston 0305

Finitura / Finishes:



K3011  
RAL

Maniglione / Handle:



Luna - T.O.R.

# Collezione Bugnati / Bugnati Collection

Pannelli pressopiegati in alluminio / Aluminum press bent panels



Bolton 0302



Arsenal 0100



Manhattan 0800

Rovere Opaco 44 UBRV44 Uberall

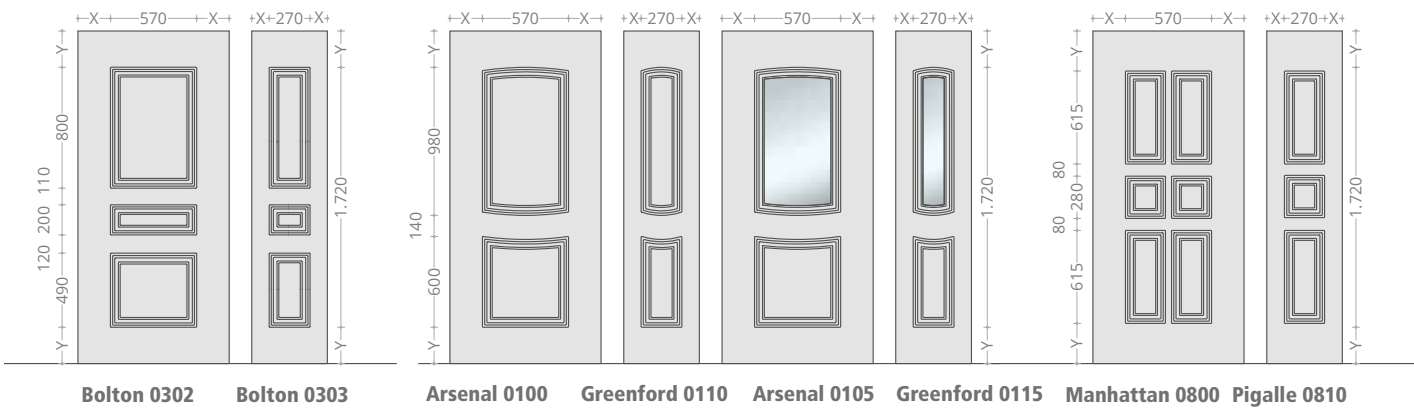

I disegni sono rappresentati in scala: 1000 mm di base per 2200 mm di altezza ; Y ha valore variabile tra 300 e 900 mm, X ha un valore variabile tra 80 mm e 160 mm





Harlem 0560



Rio 0300



Broadway 0670

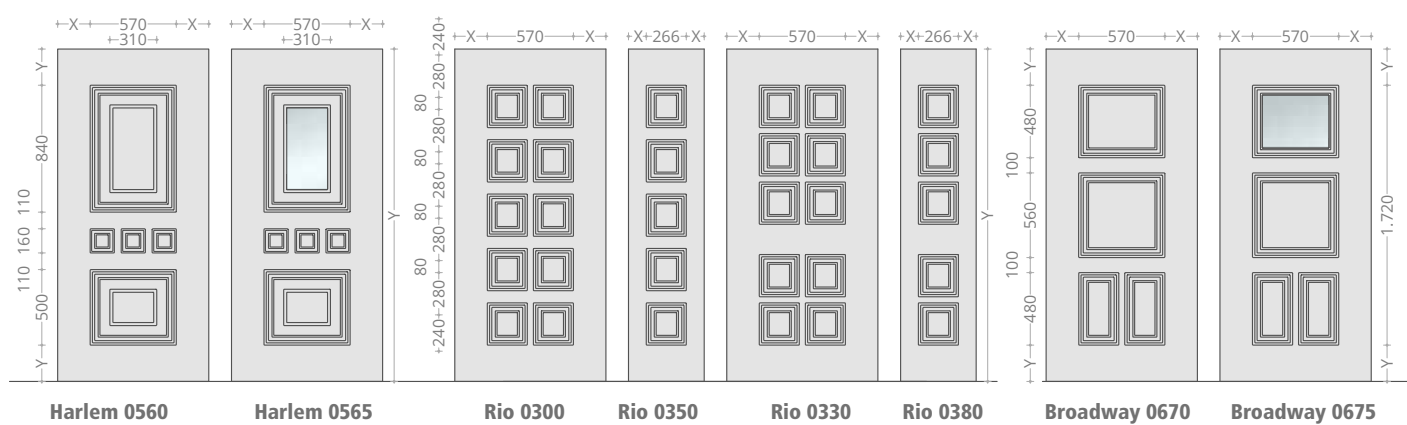

I disegni sono rappresentati in scala: 1000 mm di base per 2200 mm di altezza ; Y ha valore variabile tra 300 e 900 mm, X ha un valore variabile tra 80 mm e i 160 mm

# Collezione Bugnati / Bugnati Collection

Pannelli pressopiegati in alluminio / Aluminum press bent panels



Darwen 0141



Rambblas 0400



Cardiff 0790

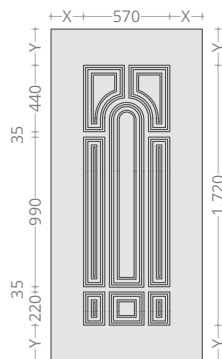

Darwen 0141

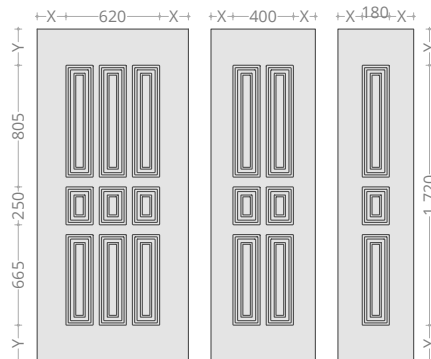

Rambblas 0400

Rambblas 0410

Rambblas 0420

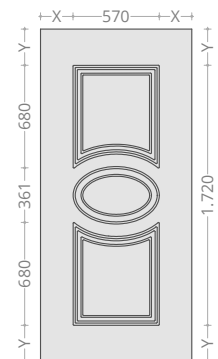

Cardiff 0790

I disegni sono rappresentati in scala: 1000 mm di base per 2200 mm di altezza ; Y ha valore variabile tra 300 e 900 mm, X ha un valore variabile tra 80 mm e 160 mm



Orlando 0401

RAL Lucido 4009



Input 1040



Brera 0500

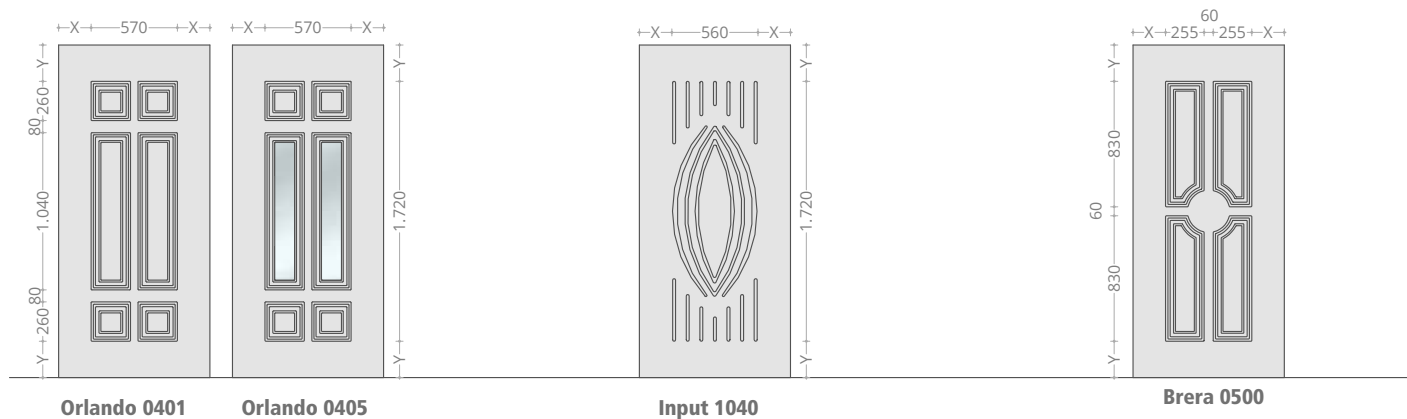

I disegni sono rappresentati in scala: 1000 mm di base per 2200 mm di altezza ; Y ha valore variabile tra 300 e 900 mm, X ha un valore variabile tra 80 mm e i 160 mm

# Collezione Bugnati / Bugnati Collection

Pannelli pressopiegati in alluminio / Aluminum press bent panels



Kenton Sx0125



Kenton Sx0120



Darling 1112

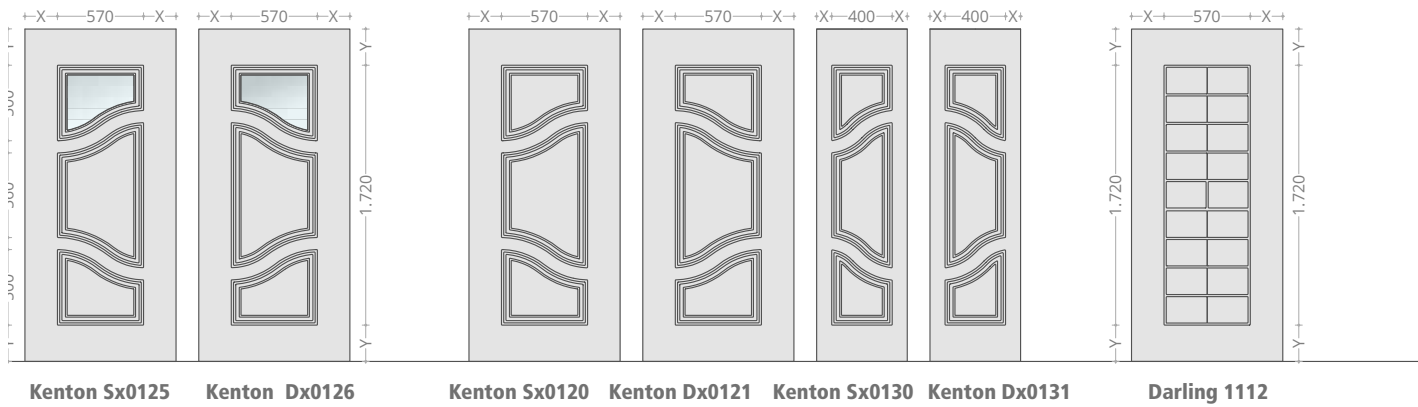

I disegni sono rappresentati in scala: 1000 mm di base per 2200 mm di altezza ; Y ha valore variabile tra 300 e 900 mm, X ha un valore variabile tra 80 mm e 160 mm



Modello / Door Model: Lx-Bugnati 1 Anta  
Finiture / Finishes: RAL K7033  
Maniglione / Handle: Flesso - BU2054

## Collezione Bugnati / Bugnati Collection

Pannelli pressopiegati in alluminio / Aluminum press bent panels



Minerva 1111



Mitte 1113

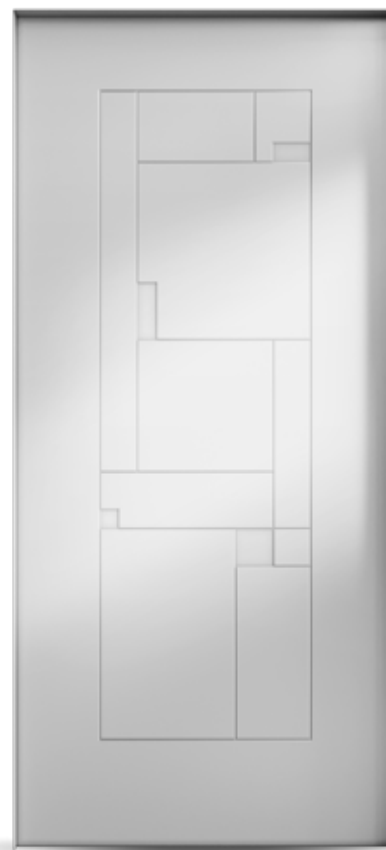

Russel 0540

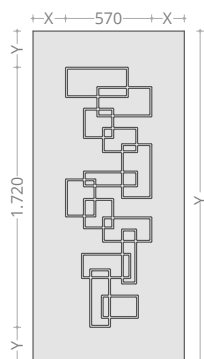

Minerva 1111

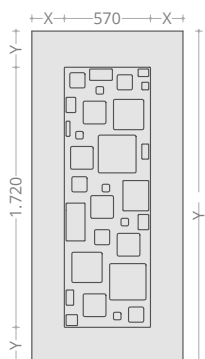

Mitte 1113

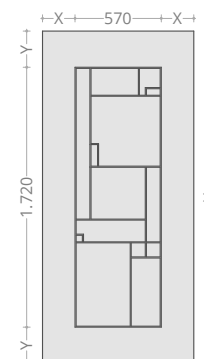

Russel 0540

I disegni sono rappresentati in scala: 1000 mm di base per 2200 mm di altezza ; *Y* ha valore variabile tra 300 e 900 mm, *X* ha un valore variabile tra 80 mm e i 160 mm



Concorde 0574



Greenwich 1106



Brooklyn 1105

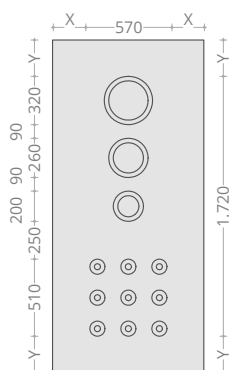

Concorde 0574

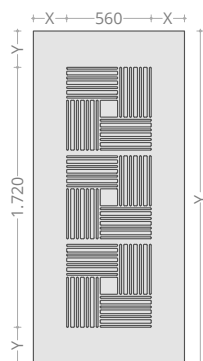

Greenwich 1106

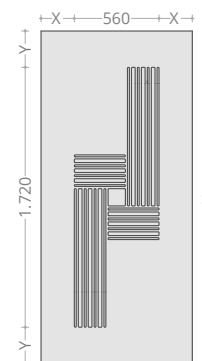

Brooklyn 1105

I disegni sono rappresentati in scala: 1000 mm di base per 2200 mm di altezza ; Y ha valore variabile tra 300 e 900 mm, X ha un valore variabile tra 80 mm e i 160 mm







Modello / Door Model: Lx-Bugnati 1 Anta  
Finiture / Finishes: Terra di Siena 11 MBTS11 Marbel  
Maniglione / Handle: Maniglione Venere - BU1064

# Collezione Bugnati / Bugnati Collection

Pannelli pressopiegati in alluminio / Aluminum press bent panels



Precox Sx1015



Precox Sx1010



Display 1030

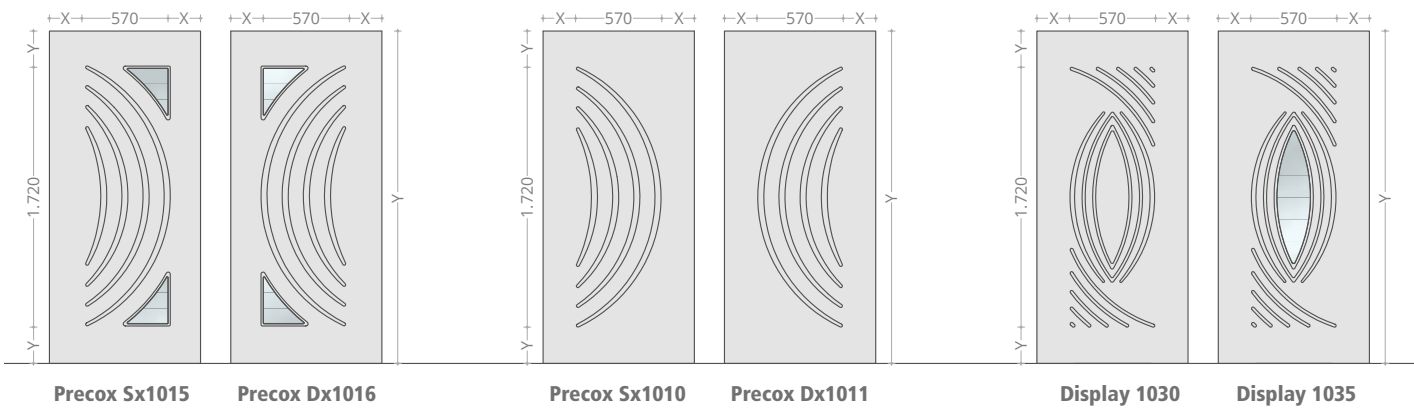

I disegni sono rappresentati in scala: 1000 mm di base per 2200 mm di altezza ; Y ha valore variabile tra 300 e 900 mm, X ha un valore variabile tra 80 mm e i 160 mm



Shibuya 1110



Babila 1102



Clotilde 1103

Normal VEZFNR Velvet

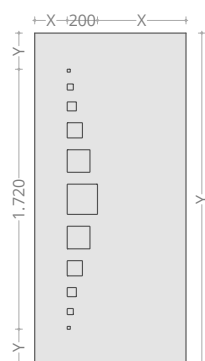

Shibuya 1110

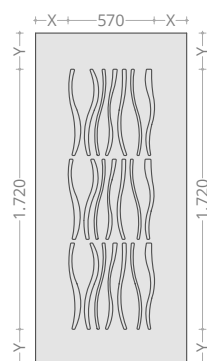

Babila 1102

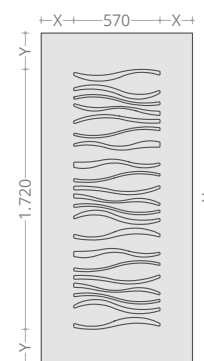

Clotilde 1103

I disegni sono rappresentati in scala: 1000 mm di base per 2200 mm di altezza ; Y ha valore variabile tra 300 e 900 mm, X ha un valore variabile tra 80 mm e i 160 mm

# Collezione Bugnati / Bugnati Collection

Pannelli pressopiegati in alluminio / Aluminum press bent panels



Mayor 0430



Ginza 1104



Ueno 1101

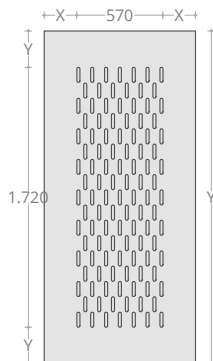

Mayor 0430

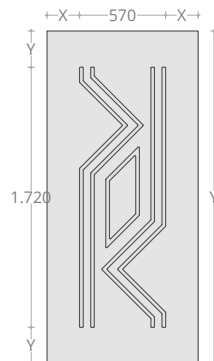

Ginza 1104

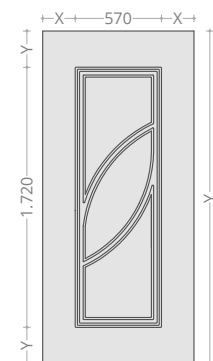

Ueno 1101

I disegni sono rappresentati in scala: 1000 mm di base per 2200 mm di altezza ; Y ha valore variabile tra 300 e 900 mm, X ha un valore variabile tra 80 mm e i 160 mm



Modello / Door Model: Lx-Bugnati 1 Anta con Sopraluce  
Finiture / Finishes: RAL 5015  
Maniglione / Handle: Zen - BU2364

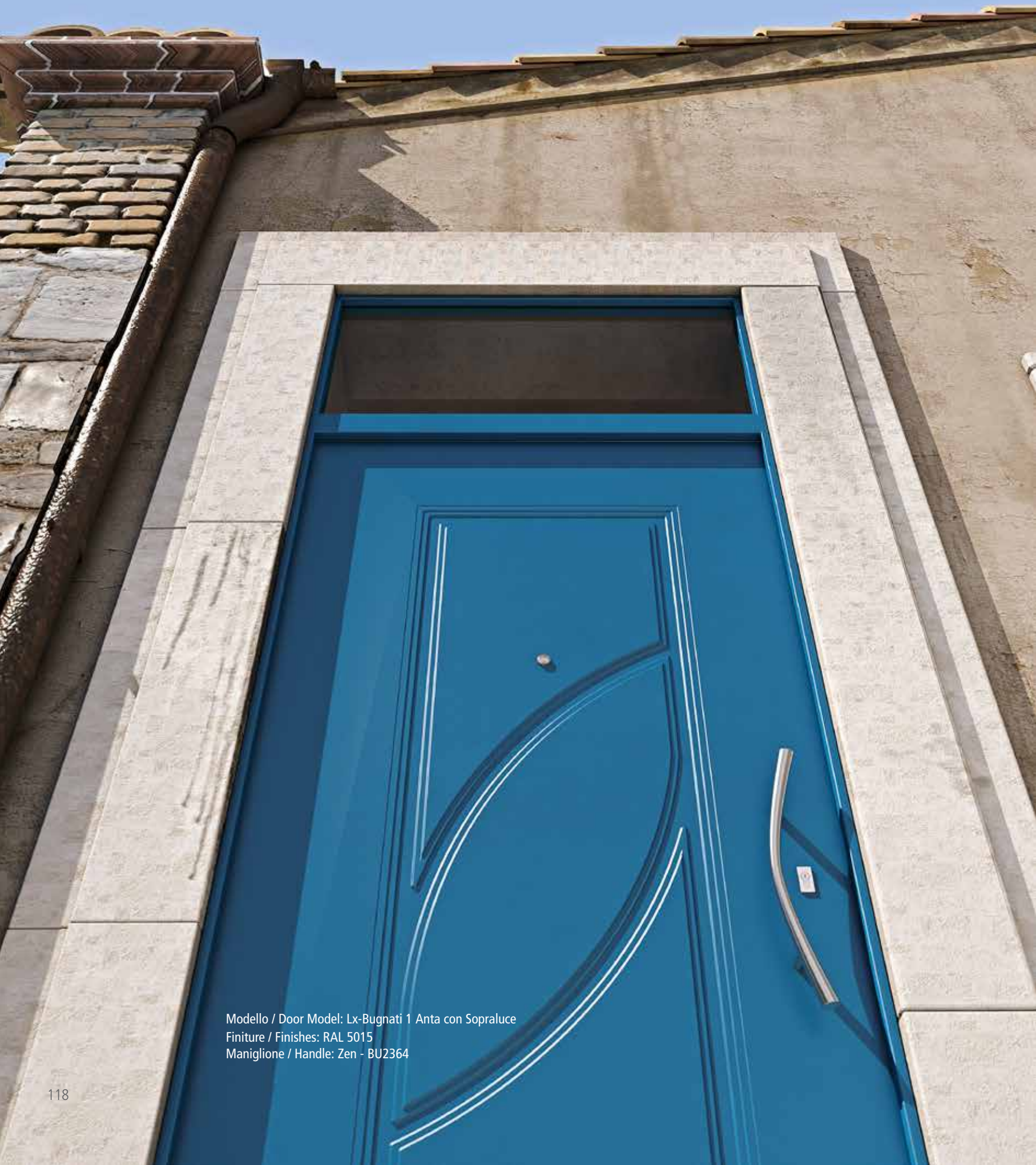

Modello / Door Model: Lx-Bugnati 1 Anta con Sopraluce  
Finiture / Finishes: RAL 5015  
Maniglione / Handle: Zen - BU2364

# Collezione Bugnati / Bugnati Collection

Pannelli presspiegati in alluminio / Aluminum press bent panels



Barberini 0533



Toronto 1140



Cascais 0580

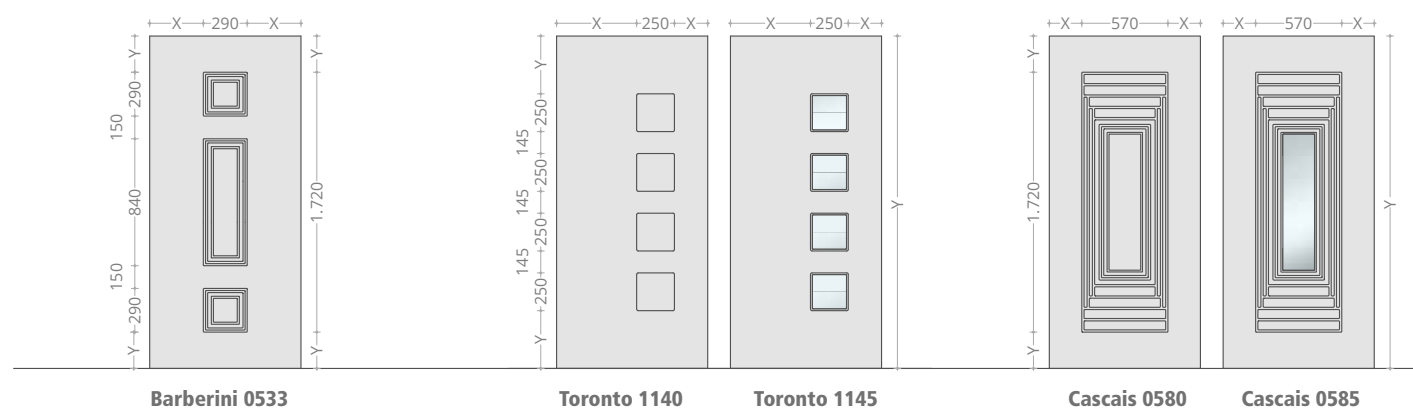

I disegni sono rappresentati in scala: 1000 mm di base per 2200 mm di altezza ; *Y* ha valore variabile tra 300 e 900 mm, *X* ha un valore variabile tra 80 mm e i 160 mm

## Collezione Bugnati / Bugnati Collection

Pannelli pressopiegati in alluminio / Aluminum press bent panels



Bastiglia 0490



Kennington 0160



Houston 0511

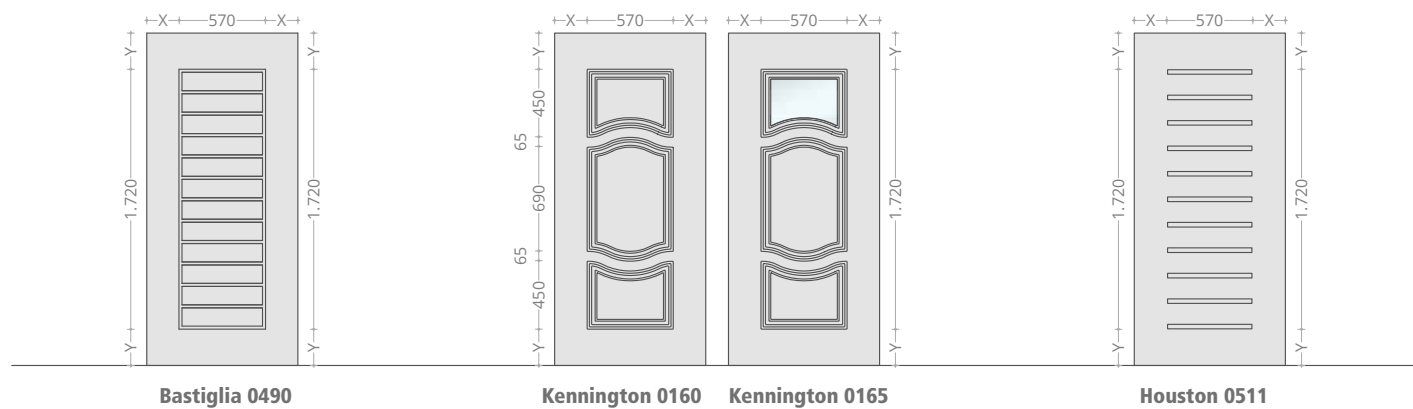

I disegni sono rappresentati in scala: 1000 mm di base per 2200 mm di altezza ; Y ha valore variabile tra 300 e 900 mm, X ha un valore variabile tra 80 mm e 160 mm





Bios Sx1080



Bit Sx1070



Web Sx1060

RAL 3032

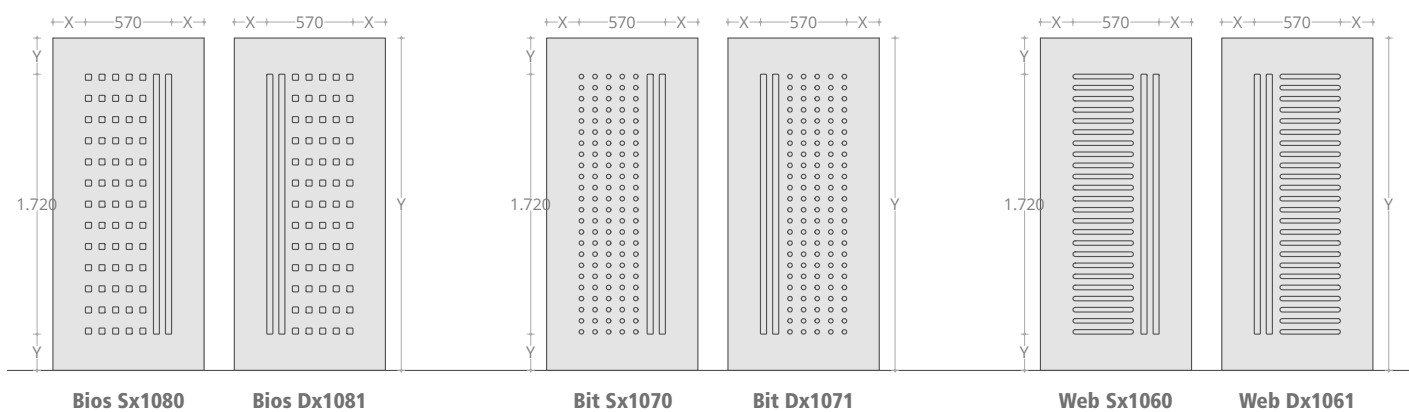

I disegni sono rappresentati in scala: 1000 mm di base per 2200 mm di altezza ; Y ha valore variabile tra 300 e 900 mm, X ha un valore variabile tra 80 mm e i 160 mm

# Collezione Bugnati / Bugnati Collection

Pannelli pressopiegati in alluminio / Aluminum press bent panels



Carnaby 0900



Carnaby 0950



Madison 0780

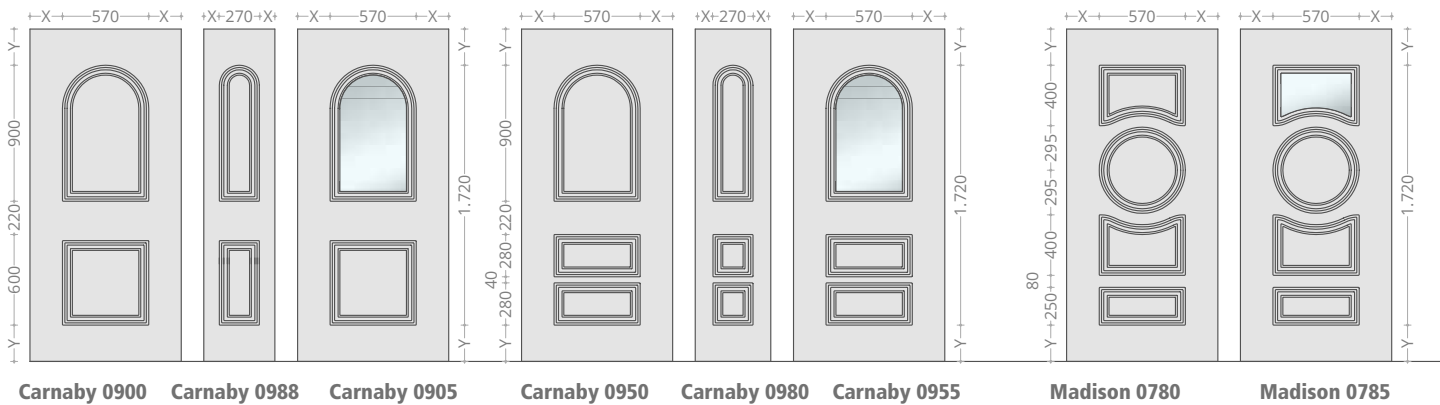

I disegni sono rappresentati in scala: 1000 mm di base per 2200 mm di altezza ; *Y* ha valore variabile tra 300 e 900 mm, *X* ha un valore variabile tra 80 mm e i 160 mm

Modello / Door Model: Lx-Bugnati 1 Anta con Sopraluce  
Finiture / Finishes: Grigio Chiaro Grinz GRIGCH Polycrom  
Maniglione / Handle: Rain 600 - BU3468

Collezione Bugnati



Ponzio catalogo Pannelli

Modello / Door Model: Lx-Bugnati 1 Anta con Sopraluce  
Finiture / Finishes: Grigio Chiaro Grinz GRIGCH Polycrom  
Maniglione / Handle: Rain 600 - BU3468





# Collezione Bugnati / Bugnati Collection

Pannelli pressopiegati in alluminio / Aluminum press bent panels



Waterloo 0520



Monaco 1120



Istanbul 1130

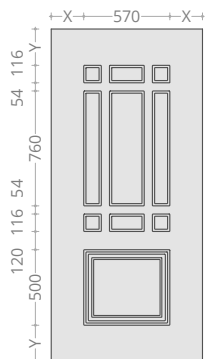

Waterloo 0520

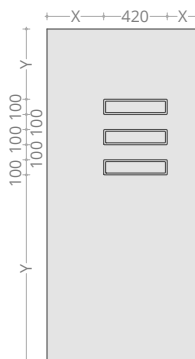

Monaco 1120

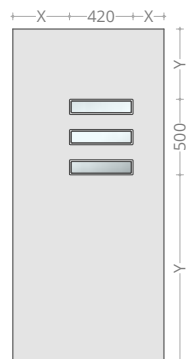

Monaco 1125

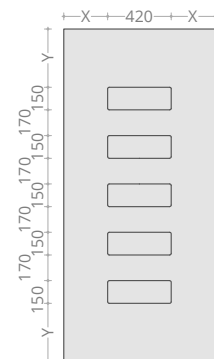

Istanbul 1130

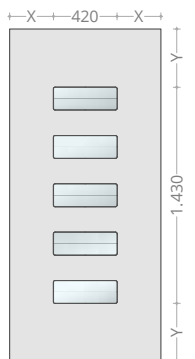

Istanbul 1135

I disegni sono rappresentati in scala: 1000 mm di base per 2200 mm di altezza ; Y ha valore variabile tra 300 e 900 mm, X ha un valore variabile tra 80 mm e i 160 mm



Modello / Door Model: Lx-Bugnati 2 Ante Simmetriche  
Finiture / Finishes: Cannella Ultra BDCN11 Brased  
Maniglione / Handle: Mitica - BU890064





Modello / Door Model: Lx-Bugnati 2 Ante Simmetriche  
Finiture / Finishes: Cannella Ultra BDCN11 Brased  
Maniglione / Handle: Mitica - BU890064

## Fermavetro Con Cornice

Versione con cornice complanare e cornice a sormonto



Versione Con Cornice Complanare



Versione Con Cornice A Sormonto

## Fermavetro Con Vetro Inserito

Versione con vetro inserito con cornice e vetro inserito semplice /



Versione Vetro Inserito Con Cornice



Versione Vetro Inserito Semplice

## Spessore Pannelli Con Vetro

Specifiche spessore pannelli e spessore vetri con fermavetro a sormonto, con fermavetro complanare, con vetro inserito, con cornice e vetro inserito semplice.

Spessore Pannello		22 mm	26 mm	30 mm	31 mm	35 mm	40 mm
<b>MDF</b>	Complanare				spessore vetro 22 mm		
	Sormonto	spessore vetro 22 mm					
	Inserito Cornice				spessore vetro 22 mm		
	Inserito Semplice				spessore vetro 22 mm		
<b>PIR</b>	Complanare						
	Sormonto			spessore vetro 30 mm			
	Inserito Cornice			spessore vetro 22 mm			
	Inserito Semplice			spessore vetro 22 mm			
<b>HI</b>	Complanare		spessore vetro 22 mm	spessore vetro 22 mm		spessore vetro 30 mm	spessore vetro 35 mm
	Sormonto						
	Inserito Cornice			spessore vetro 22 mm		spessore vetro 26 mm	spessore vetro 32 mm
	Inserito Semplice			spessore vetro 22 mm		spessore vetro 26 mm	spessore vetro 32 mm
<b>POL</b>	Complanare				spessore vetro 22 mm		
	Sormonto	spessore vetro 22 mm					
	Inserito Cornice				spessore vetro 22 mm		
	Inserito Semplice				spessore vetro 22 mm		

# Modelli Pannelli Con Vetro

Vetro complanare e a sormonto

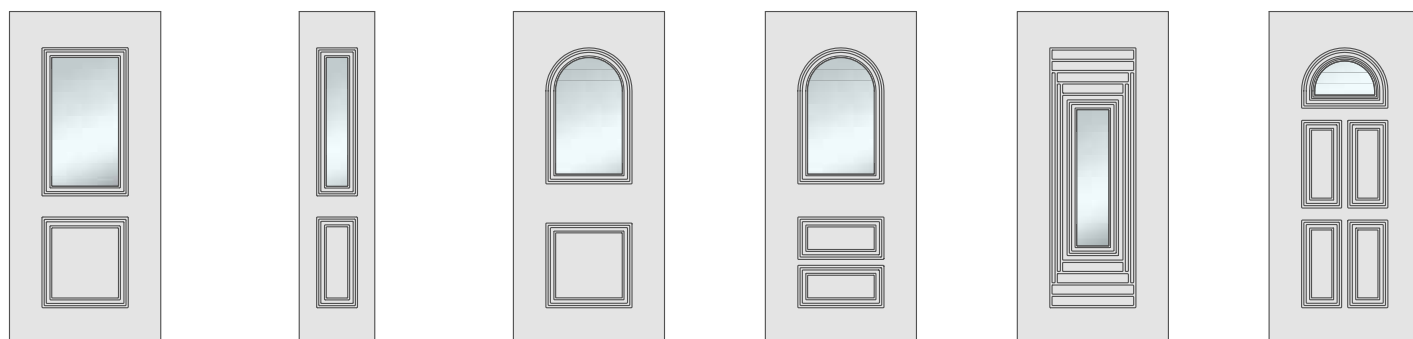

Aston 0305

Aston 0315

Carnaby 0905

Carnaby 0955

Cascais 0585

Montparnasse 0755

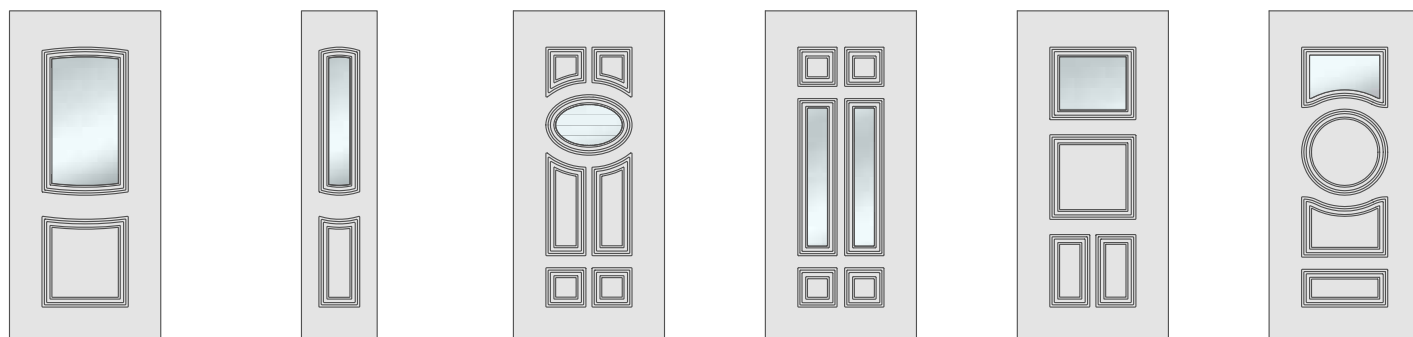

Arsenal 0105

Greenford 0115

Regent 0775

Orlando 0405

Broadway 0675

Madison 0785

Vetro inserito cornice

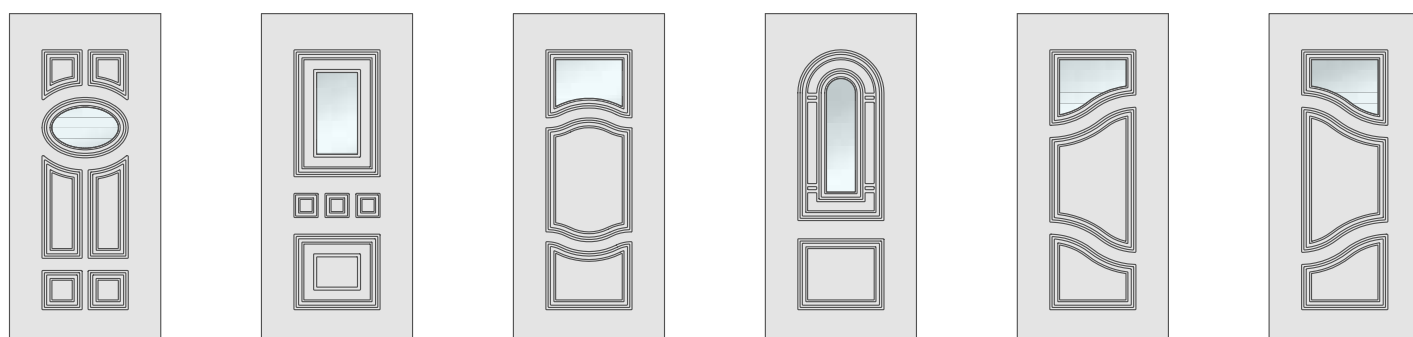

Regent 0775

Harlem 0565

Kennington 0165

Piccadilly 0880

Kenton Sx0125

Kenton Dx0126

Vetro inserito semplice

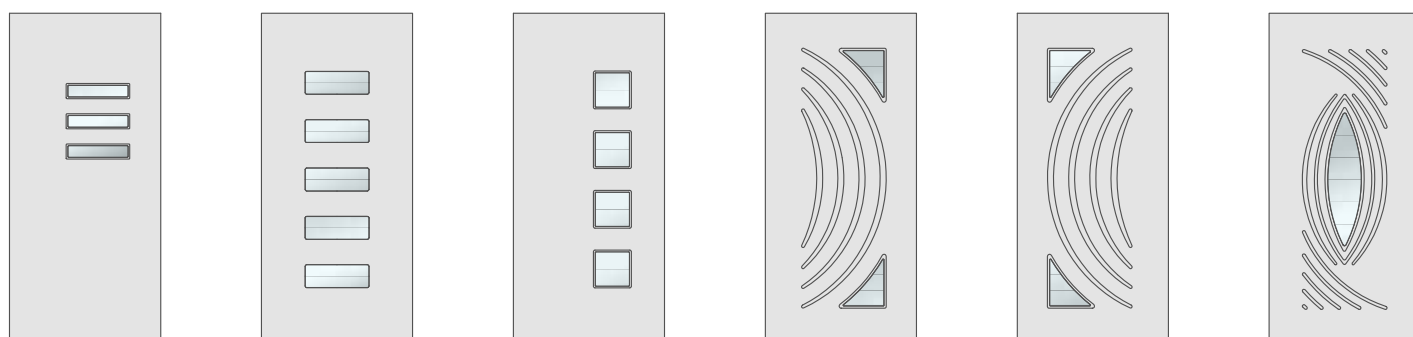

Monaco 1125

Istanbul 1135

Toronto 1145

Precox Sx1015

Precox Dx1016

Display 1035

# Collezione Bugnati / Bugnati Collection

Pannelli pressopiegati in alluminio / Aluminum press bent panels



Montparnasse 0750



Regent 0770



Queens 0630

Pioppo 35 HDPP35 Uberall HD

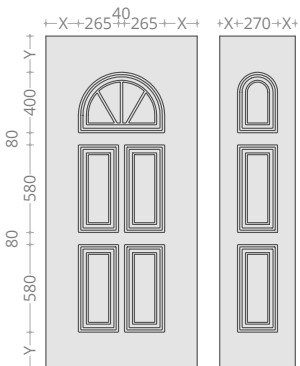

Montparnasse 0750

Montparnasse 0760

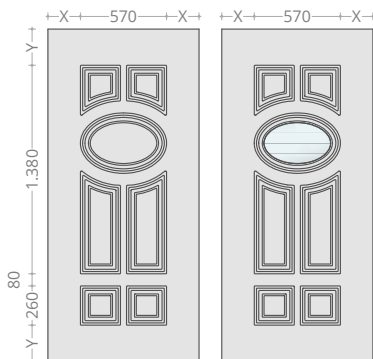

Regent 0770

Regent 0775

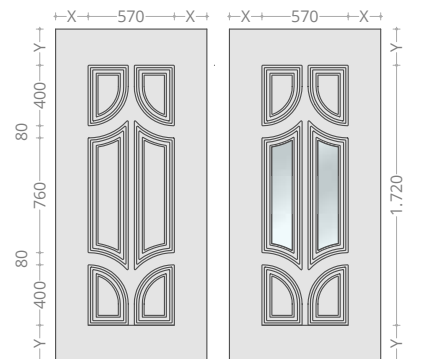

Queens 0630

Queens 0635

I disegni sono rappresentati in scala: 1000 mm di base per 2200 mm di altezza ; Y ha valore variabile tra 300 e 900 mm, X ha un valore variabile tra 80 mm e i 160 mm



West 0322



Piccadilly 0850



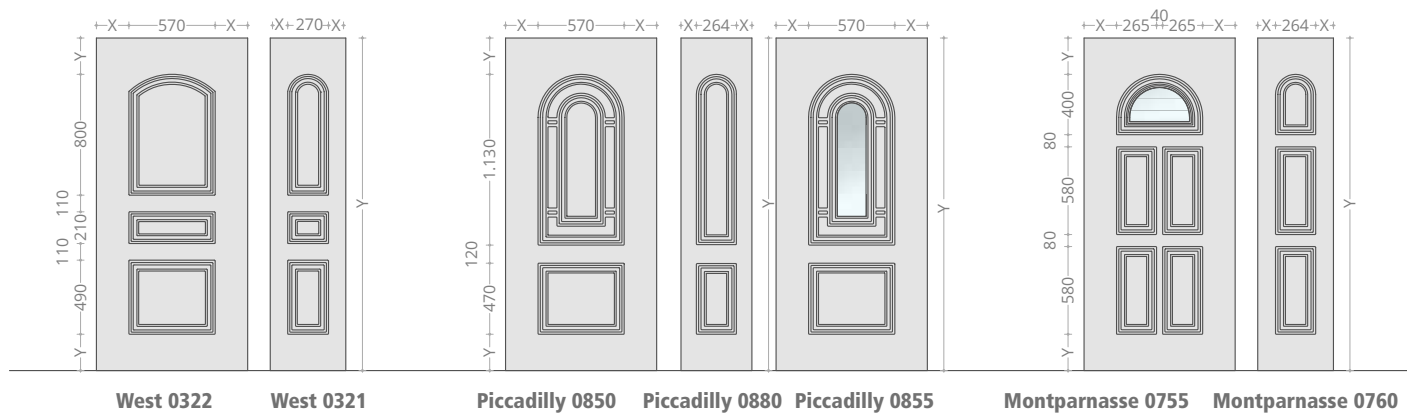

Montparnasse 0755



I disegni sono rappresentati in scala: 1000 mm di base per 2200 mm di altezza ;  $Y$  ha valore variabile tra 300 e 900 mm,  $X$  ha un valore variabile tra 80 mm e i 160 mm

# Tipologie Pannelli Plana

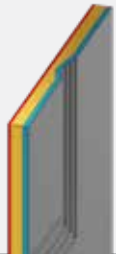
MDF, P.I.R., H.I., POL

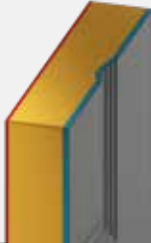
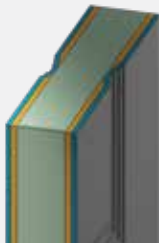
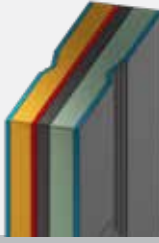
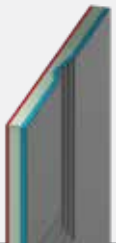
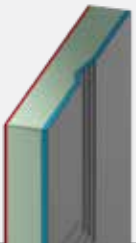
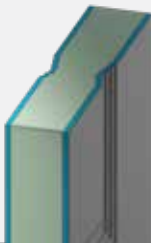
mm	7 mm	15 mm	22 mm	25 mm	26 mm	
INT						
<b>MDF</b>						
EXT						
Kg/m <sup>2</sup>   W/m <sup>2</sup>   dB	9,60   5,06   ndp	15,80   4,23   ndp	24,40   3,63   27			
INT						
<b>PIR</b>						
EXT						
Kg/m <sup>2</sup>   W/m <sup>2</sup>   dB				17,40   1,29   34		
INT						
<b>HI</b>						
EXT						
Kg/m <sup>2</sup>   W/m <sup>2</sup>   dB					23,00   1,61   34	
INT						
<b>POL</b>						
EXT						
Kg/m <sup>2</sup>   W/m <sup>2</sup>   dB	7,40   2,88   ndp	8,40   1,79   ndp	12,10   1,28   27			





**Gamma M.D.F.** I pannelli in M.D.F. garantiscono la robustezza, solidità e resistenza delle strutture oltre ad assicurare buone qualità di idrorepellenza

**Gamma P.I.R.** I pannelli in PIR offrono eccezionali garanzie: eccellente isolamento termico; stabilità dimensionale alle alte e basse temperature; isolamento acustico; idrorepellenza; leggerezza.

**H.I. Anima flessibile: pannelli da grandi performance.** Portoncini d'ingresso che non temono l'acqua e il vento, che isolano dal caldo, dal freddo e dai rumori. Sicurezza, clima, silenzio: il comfort è un valore che Ponzio mette al primo posto. Da oggi, inoltre, con la nuova tecnologia e l'inserimento dell'anima flessibile, i pannelli in alluminio limitano il fenomeno della dilatazione termica, derivante dall'irraggiamento solare.

**Gamma P.O.L.** Leggerezza e grandi prestazioni tecniche per il pannello in P.O.R., poliuretano ad alta densità, che sposa leggerezza e resistenza.



-  Lamiera in alluminio 1,2 mm / *Aluminum sheet 1,2 mm*
-  MDF / *MDF*
-  Lamiera in alluminio 0,4 mm / *Aluminum sheet 0,4 mm*
-  H.I. Anima Flessibile / *Flexible core H.I.*
-  Poliuretano Isolante HD / *Polyurethane non-conducting HD*

- INT = Interno / *Interior*
- EXT = Esterno / *Exterior*
- Kg/m<sup>2</sup> = Peso al Metro Quadro / *Weight per Square Meter*
- W/m<sup>2</sup> = Isolamento Termico / *Thermal Insulation*
- dB = Isolamento Acustico / *Soundproofing*

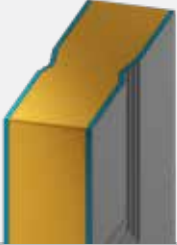
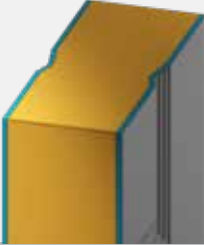
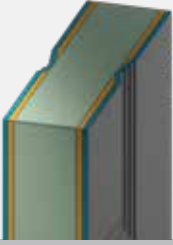
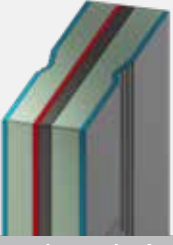
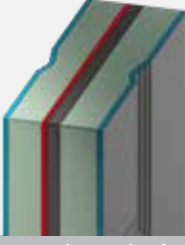
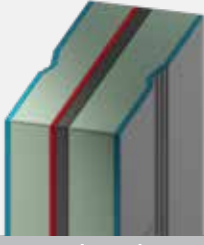
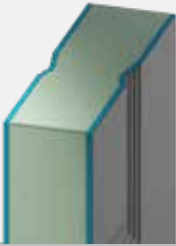
	30 mm	31 mm	35 mm	40 mm	42 mm
					
		31,50   3,07   28			56,00   2,62   ndp
					
	18,20   1,03   33				
					
	18,70   1,04   ndp		19,50   0,89   ndp	20,30   0,78   33	
					
		13,60   0,93   25			

**Gamma M.D.F.:** M.D.F. panels ensure robustness, solidity, and structural resistance while also guaranteeing good water repellent qualities.

**Gamma P.I.R.:** PIR panels offer exceptional guarantees, including excellent thermal insulation, dimensional stability at high and low temperatures, sound insulation, water repellency, and lightness.

**H.I.** Flexible core: high-performance panels. Entrance doors that withstand water and wind, providing insulation from heat, cold, and noise. Safety, climate, and silence: comfort is a value that Ponzio places first. Moreover, with the new technology and the insertion of the flexible core, aluminum panels limit the phenomenon of thermal expansion resulting from solar radiation.

**Gamma P.O.L.** Leggerezza e grandi prestazioni tecniche per il pannello in P.O.R., poliuretano ad alta densità, che sposa leggerezza e resistenza.

# Maniglioni, Maniglie e Accessori



Ponzio  
pan  
nel  
i



## Collezione Maniglioni / Pull handles collection



Mitica  
Inox 316 / Stainless steel  
L 1360 - I 1200 mm  
BU890074



Mitica  
Inox 316 / Stainless steel  
L 1150 - I 1000 mm  
BU890064



Diva  
Acciaio Inox AISI 316 / Stainless steel  
L 500 mm - I 300 mm  
BU890104

## Collezione Maniglioni / Pull handles collection



Gloria  
Acciaio Inox 316/ Stainless steel  
L 1360 - l 1200 mm  
BU890094

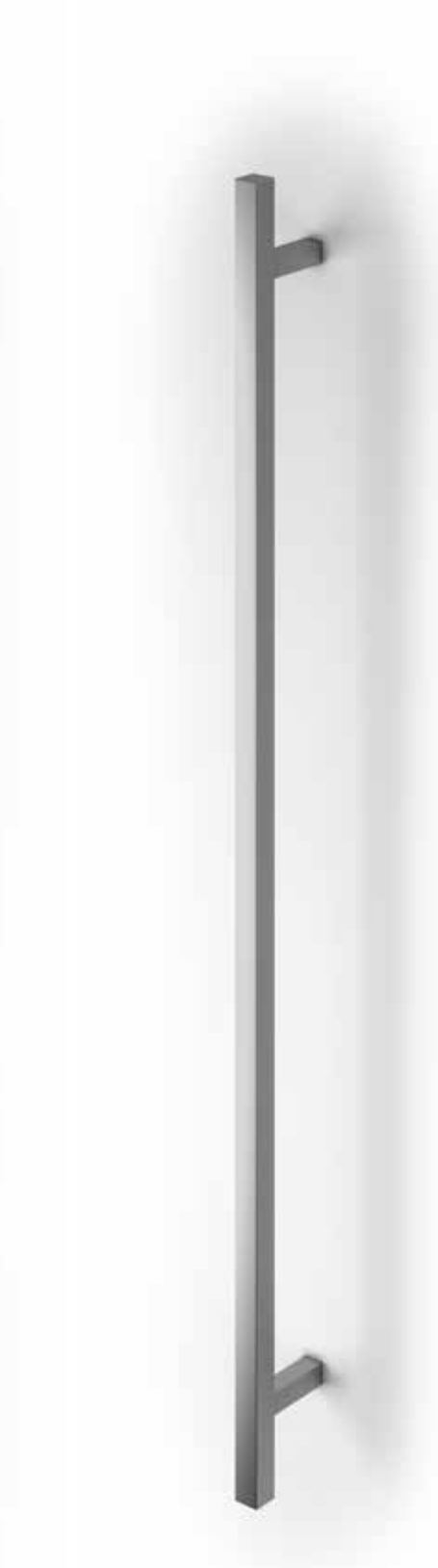

Gloria  
Acciaio Inox 316/ Stainless steel  
L 1160 - l 1000 mm  
BU890084



Wave  
Cromo sat.  
L 750 mm  
BU890044

## Collezione Maniglioni / Pull handles collection



Maniglione Biometrico Tondo d 30 mm ,  
staffa 90° o 35° ,  
lettore frontale o retro , inox o nero,  
L 600-800-1000-1500-1800-2100-2400



Maniglione Biometrico quadrato 30 x 30  
mm , staffa 90° o 35° ,  
lettore frontale o retro , inox o nero,  
L 600-800-1000-1500-1800-2100-2400



Maniglione Biometrico rettangolare 40 x  
20 mm , staffa 90° o 35° ,  
lettore frontale o retro , inox o nero,  
L 600-800-1000-1500-1800-2100-2400

## Collezione Maniglioni / Pull handles collection



Letizia  
Acciaio Inox 316/ Stainless Steel  
L 660 mm - I 600 mm  
BU890134



Luxury  
Acciaio inox AISI 316L  
L 650 mm I 500 mm  
BU3738



Trendy  
Acciaio Inox AISI 316L  
L 600 mm I 500 mm  
BU3648

## Collezione Maniglioni / Pull handles collection



Arca  
Acciaio inox AISI 316L  
L 500 mm  
BU890114



Mohicano  
Acciaio inox AISI 316L  
L 370 mm - l 350 mm  
BU3748



Noa  
Cromo sat.  
L 500 mm  
BU890024



Letizia  
Acciaio Inox 316/ Stainless Steel  
L 360 mm - l 300 mm  
BU890124



Fashion  
Inox AISI 316L  
L 530 mm - l 500 mm  
BU3608



Fashion  
Acciaio Inox AISI 316L nero  
L 530 mm - l 500 mm  
BU3605



## Collezione Maniglioni / Pull handles collection



Puntatore  
Acciaio Inox AISI 316L  
L 320 mm - I 290 mm  
BU3588



Puntatore  
Acciaio Inox AISI 316L nero  
L 320 mm - I 290 mm  
BU3585



Magnetic  
Acciaio inox AISI 316L  
L 500 mm I 350 mm  
BU3678



Zen  
Cromo Satinato  
L 480 mm - I 450 mm  
BU2364



Rain 600  
Acciaio Inox/ Stainless steel  
L 700 mm I 600 mm  
BU3468



Rain  
Acciaio Inox/ Stainless steel  
L 420 mm I 320 mm  
BU3438

## Collezione Maniglioni / Pull handles collection



Flesso  
Cromo Satinato  
L 280 mm - I 250 mm  
BU2054



Flesso  
T.O.R.  
L 280 mm - I 250 mm  
BU2052



Flesso  
Neromat  
L 280 mm - I 250 mm  
BU2055



Luna  
Cromo Satinato  
L 270 mm I 250 mm  
BU1044



Luna  
Neromat  
L 270 mm I 250 mm  
BU1045



Luna  
T.O.R.  
L 270 mm I 250 mm  
BU1042

## Collezione Maniglioni / Pull handles collection



Sfrenato  
Acciaio inox AISI 316L  
L 380 mm I 350 mm  
BU3658



Vip  
Acciaio inox AISI 316L  
L 380 mm I 350 mm  
BU3668



Warm 250  
Starox  
L 270 mm I 250 mm  
BU3529



Venere  
Cromosatinato  
L 280 mm I 250 mm  
BU1064



Venere  
T.O.R.  
L 280 mm I 250 mm  
BU1062

## Collezione Maniglie / Handles Collection

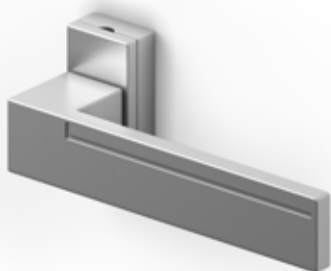

Maniglia Louise  
Cromo Satinato  
L 150 mm  
BU8604

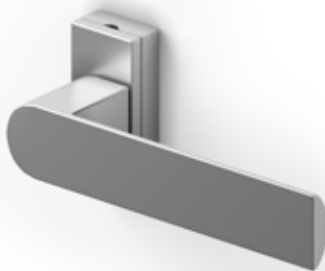

Maniglia Medea  
Cromo Satinato  
L 150 mm  
BU8904

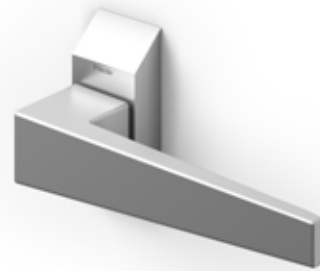

Maniglia Kikka  
Cromo Satinato  
L 150 mm  
BU 9104

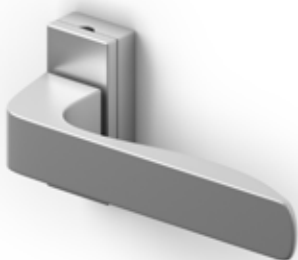

Maniglia Thelma  
Cromo Satinato  
L 150 mm  
BU8704

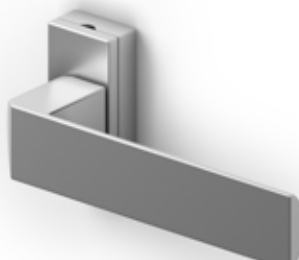

Maniglia Itaca  
Cromo Satinato  
L 150 mm  
BU8804

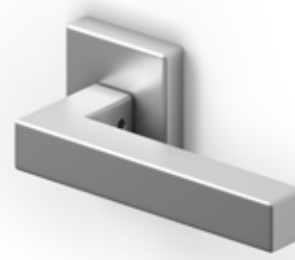

Maniglia  
Acciaio inox AISI 316  
L 140 mm  
BU1774

## Collezione Maniglie / Handles Collection



Pomolo maniglia Marte  
Starox  
L 66 mm  
BU1329



Pomolo maniglia Marte  
Cromo Satinato  
L 66 mm  
BU1324



Maniglia  
Acciaio inox AISI 316  
L 150 mm  
BU1754



Pomolo Saturno  
Cromo Satinato  
L 55 mm  
BU1364



Pomolo Cilindro  
Cromo Satinato  
L 25 mm  
BU1474



Pomolo con Limitatore D'Apertura  
Acciaio Inox AISI 316L  
Acciaio inossidabile  
Diametro 50 mm  
BU1464

## Collezione Accessori / Accessories Collection



Bocchetta Defender  
Acciaio AISI 316L  
L 30 mm x H 60 mm  
BU068



Bocchetta per serratura  
chiave sagomata  
Cromosatinato  
L 30 mm x H 60 mm  
BU034



Bocchetta per serratura  
chiave sagomata  
T.O.R.  
L 30 mm x H 60 mm  
BU032



Bocchetta per serratura  
chiave sagomata  
Neromat  
L 30 mm x H 60 mm  
BU035



Mostrina Copri Cilindro PVDH  
L 30 mm x H 60 mm  
SA874-804PVDH



Mostrina Copri Cilindro 1013  
L 30 mm x H 60 mm  
SA874-80413



Mostrina Copri Cilindro K9010  
L 30 mm x H 60 mm  
SA874-80425



Mostrina Copri Cilindro 9010  
L 30 mm x H 60 mm  
SA874-80412



Mostrina Copri Cilindro PVDX  
L 30 mm x H 60 mm  
SA874-804PVDX



Mostrina Copri Cilindro BR5  
L 30 mm x H 60 mm  
SA874-804BR5



Mostrina Copri Cilindro V.ARGE  
30 mm x H 60 mm  
SA874-80416



Mostrina Copri Cilindro Nero  
L 30 mm x H 60 mm  
SA874-804BL10



Dado Cieco fil. 6ma  
Patinet steel  
BU247



Dado Cieco fil. 6ma  
Cromosat  
BU244



Dado Cieco fil. 8ma  
Cromosat  
BU244/8



Dado Cieco fil. 8ma  
T.O.R.  
BU241/8



Spioncino  
Nickel cromato  
BU894\*



Spioncino Super Mario  
Ottone  
BU883

## Collezione Accessori / Accessories Collection



Rosetta  
Acciaio inox AISI 316L  
BU2498



Kit rosette  
Cromo Satinato  
BU2064



Coppia borchie  
Cromo satinato  
BU1414



Kit Rosette Quadre  
Acciaio Inox AISI 316L  
L 50 x 50 mm  
BU2084



Bocchetta Defender  
Cromosat  
BU074



Kit girevole per pomoli  
BU1362/BU1364/BU1371/  
BU1374  
BU09



Kit attacco non passante  
per maniglioni  
BU06



Kit passante  
Cromo satinato  
BU2424



Kit doppio attacco  
BU2441



Fissaggio doppio per Maniglione  
U3648  
BU078



Kit attacco non pass.  
per maniglioni ridotto  
BU07R

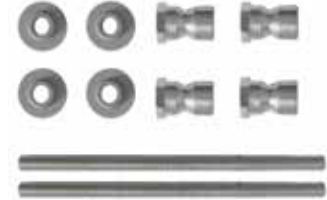

Fissaggio per Maniglione  
Acciaio Inox  
BU076



Kit non passante  
BU2401



Fissaggio per Maniglione  
Acciaio Inox  
BU075



Fissaggio Sing. per Maniglione  
Nylon BU3698  
BU079



Fissaggio sing. per Maniglione  
BU3648  
BU 077

# Abaco e Disegni 2d





12-2009

# Collezione Plana

Esempi di configurazione in scala 1:20 / 1:20 scale configuration examples

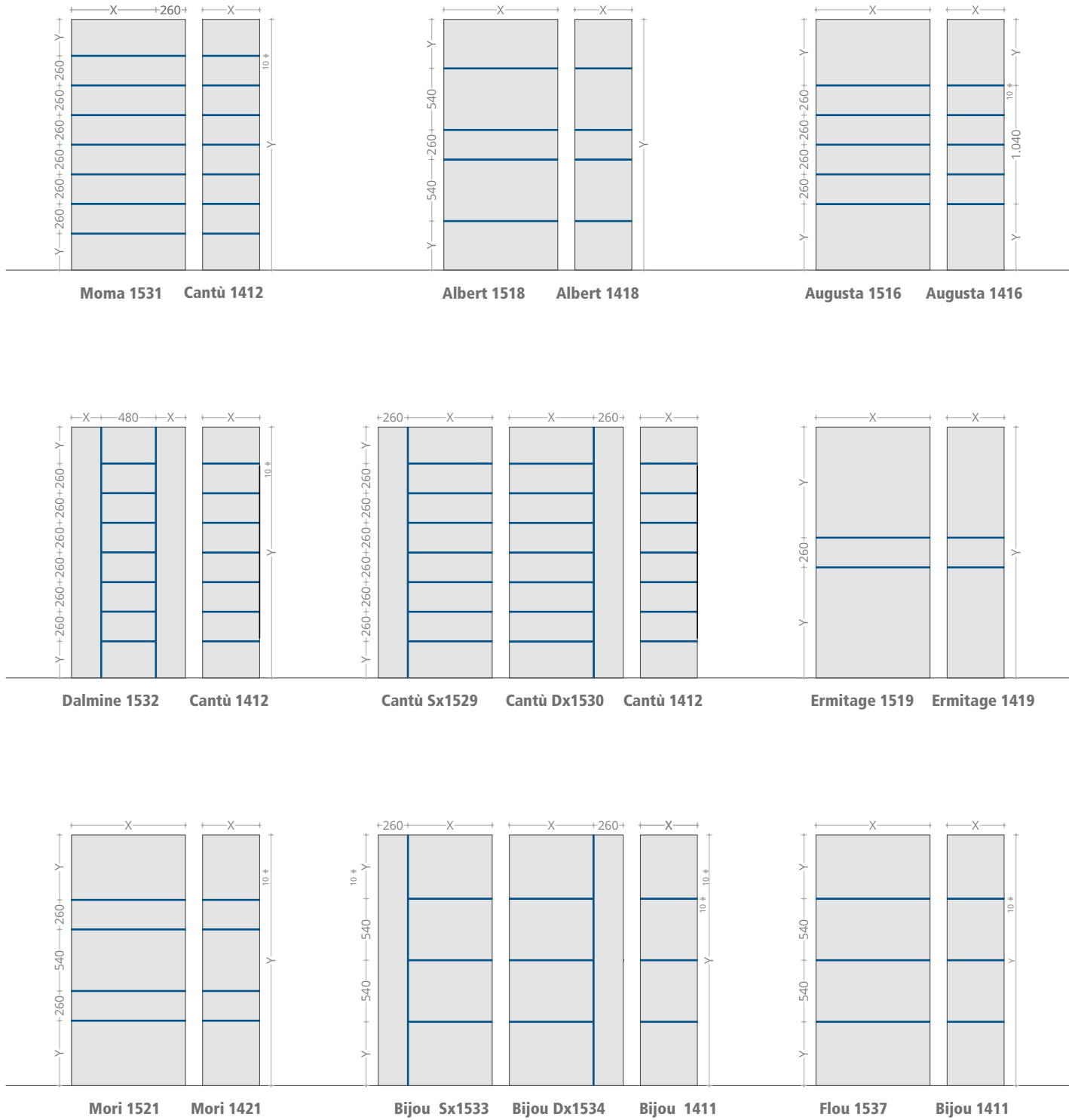

Inserto in alluminio

I disegni sono rappresentati in scala: 1000 mm di base per 2200 mm di altezza ; Y ha valore variabile tra 300 e 900 mm, X ha un valore variabile tra 80 mm e i 160 mm

# Collezione Plana

Esempi di configurazione in scala 1:20 / 1:20 scale configuration examples

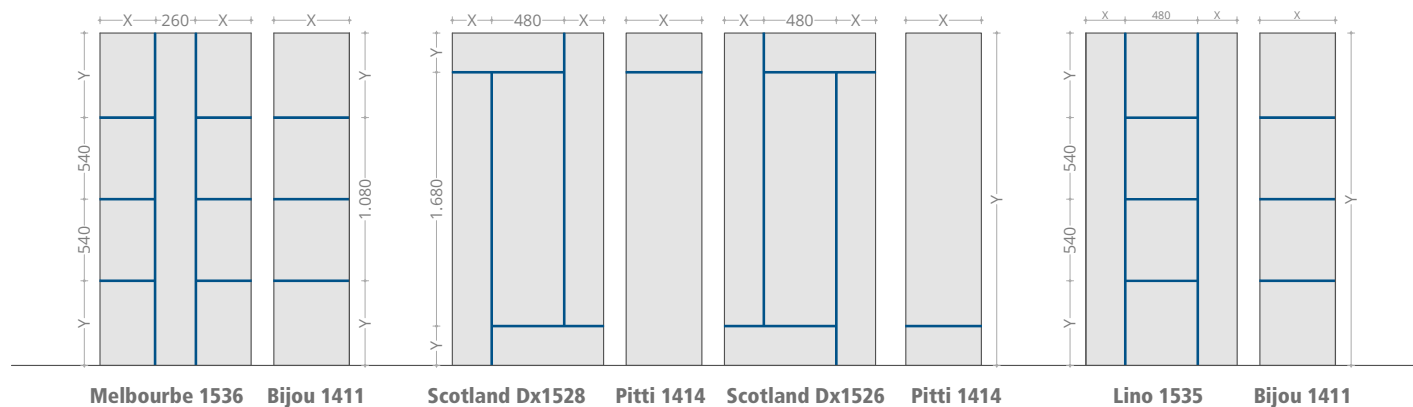
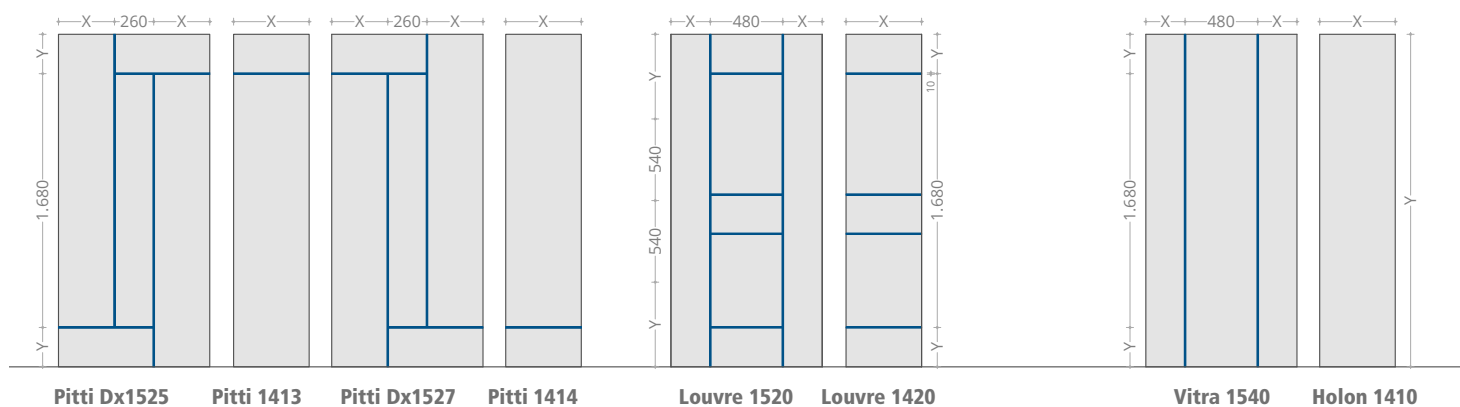
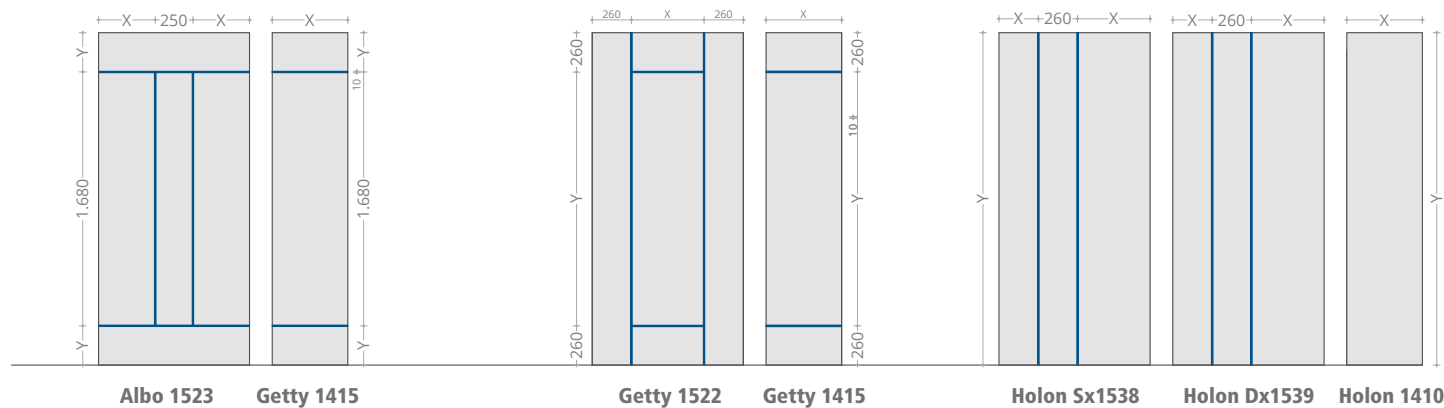

 Inserito in alluminio

I disegni sono rappresentati in scala: 1000 mm di base per 2200 mm di altezza ; Y ha valore variabile tra 300 e 900 mm, X ha un valore variabile tra 80 mm e i 160 mm





# Collezione Linea Tech

Esempi di configurazione in scala 1:20 / 1:20 scale configuration examples

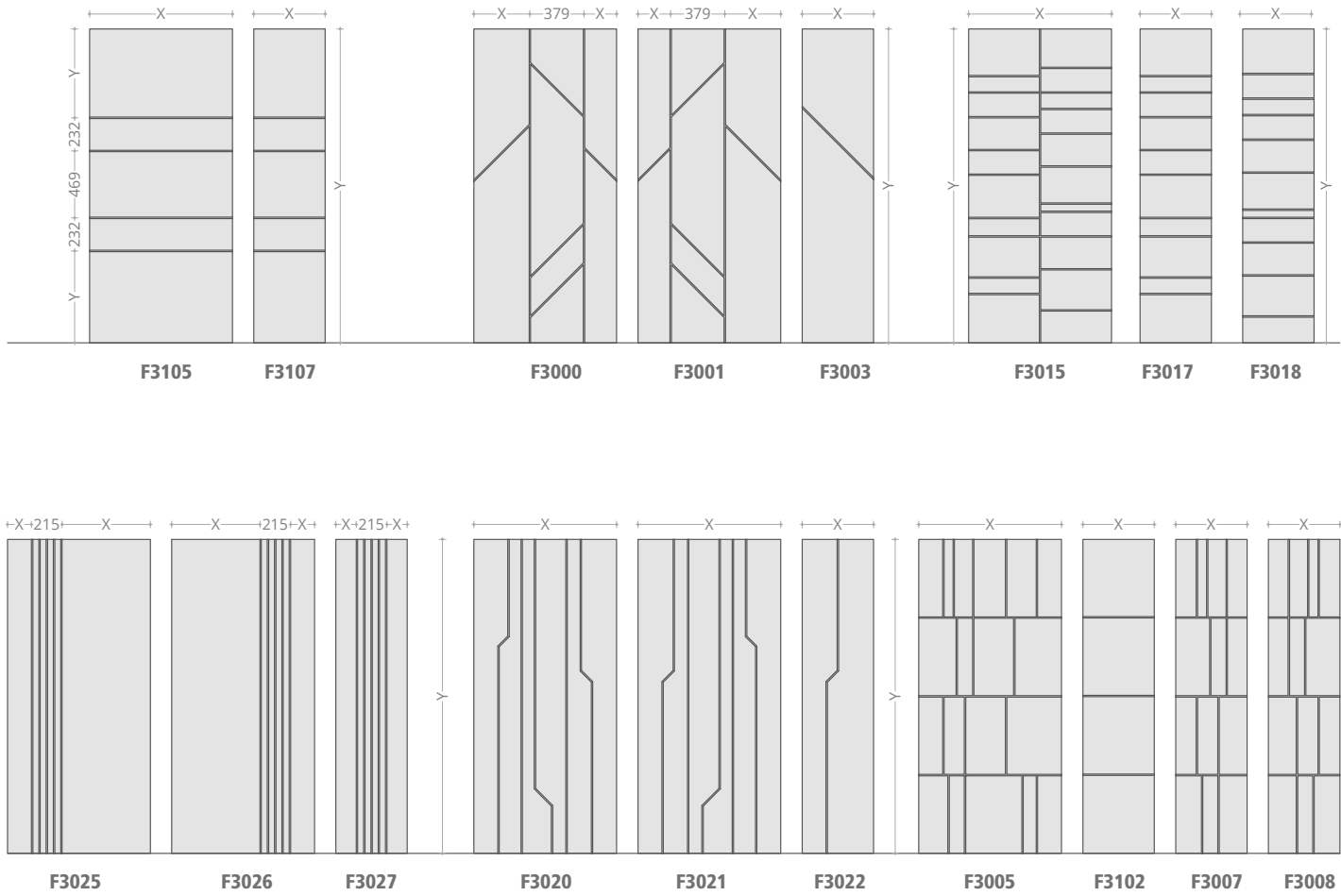

I disegni sono rappresentati in scala: 1000 mm di base per 2200 mm di altezza ;  $Y$  ha valore variabile tra 300 e 900 mm,  $X$  ha un valore variabile tra 80 mm e 160 mm

# Collezione Linea Geo

Esempi di configurazione in scala 1:20 / 1:20 scale configuration examples

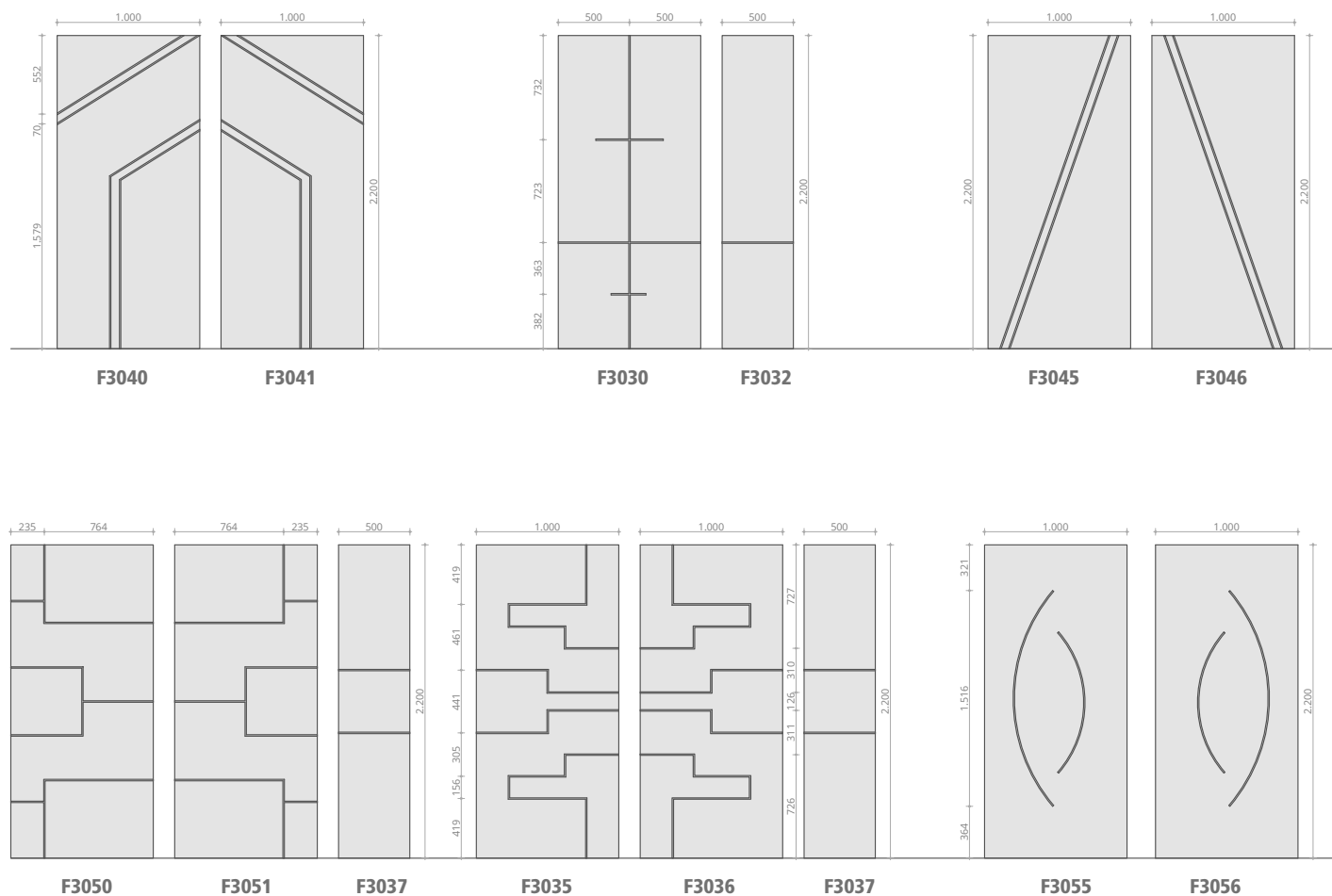

I disegni sono rappresentati in scala: 1000 mm di base per 2200 mm di altezza ; Y ha valore variabile tra 300 e 900 mm, X ha un valore variabile tra 80 mm e i 160 mm

# Collezione Linea Light

Esempi di configurazione in scala 1:20 / 1:20 scale configuration examples

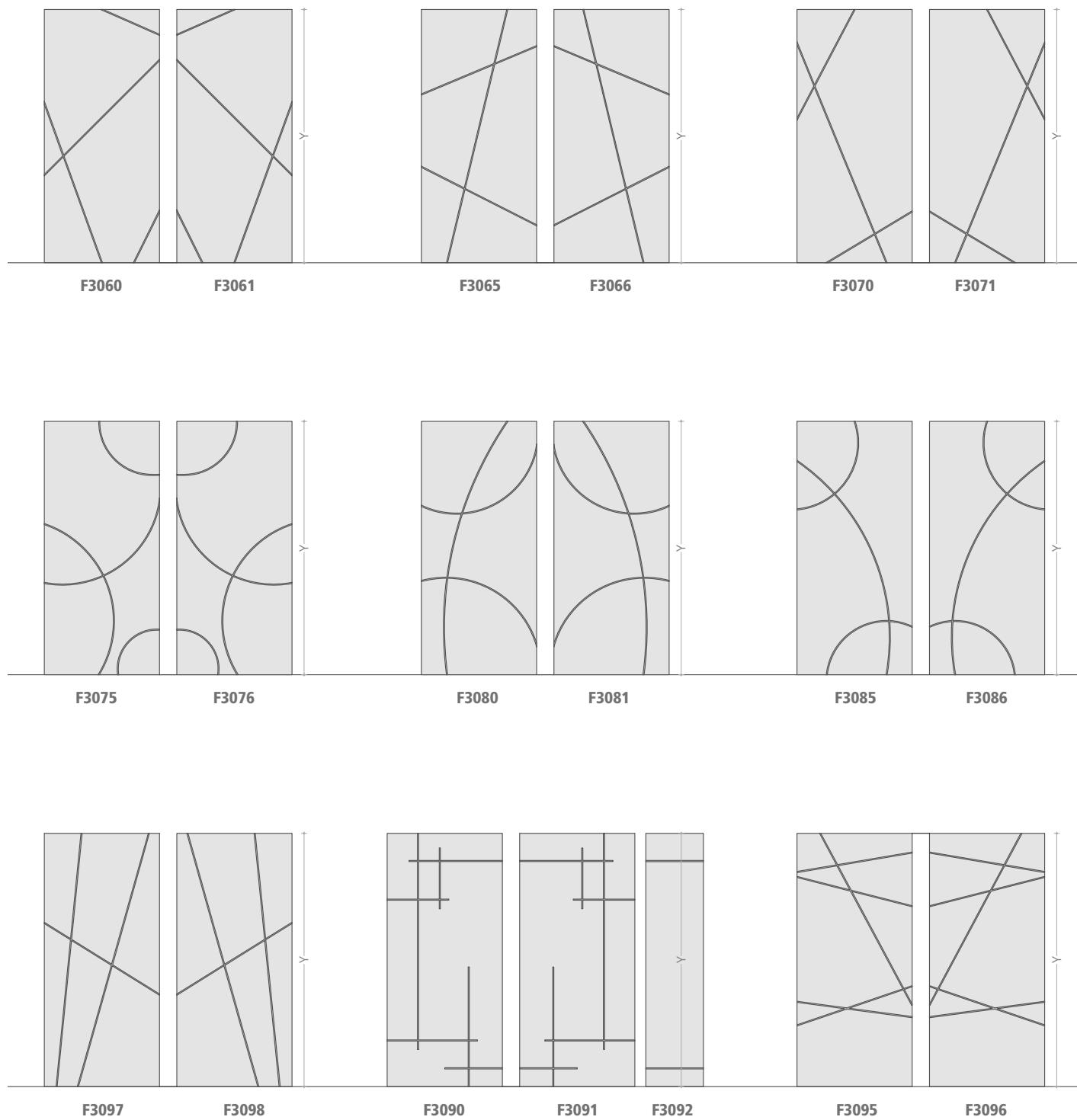

I disegni sono rappresentati in scala: 1000 mm di base per 2200 mm di altezza ; Y ha valore variabile tra 300 e 900 mm, X ha un valore variabile tra 80 mm e 160 mm



# Collezione Linea Tech Con Inserti in Alluminio

Esempi di configurazione in scala 1:20 / 1:20 scale configuration examples

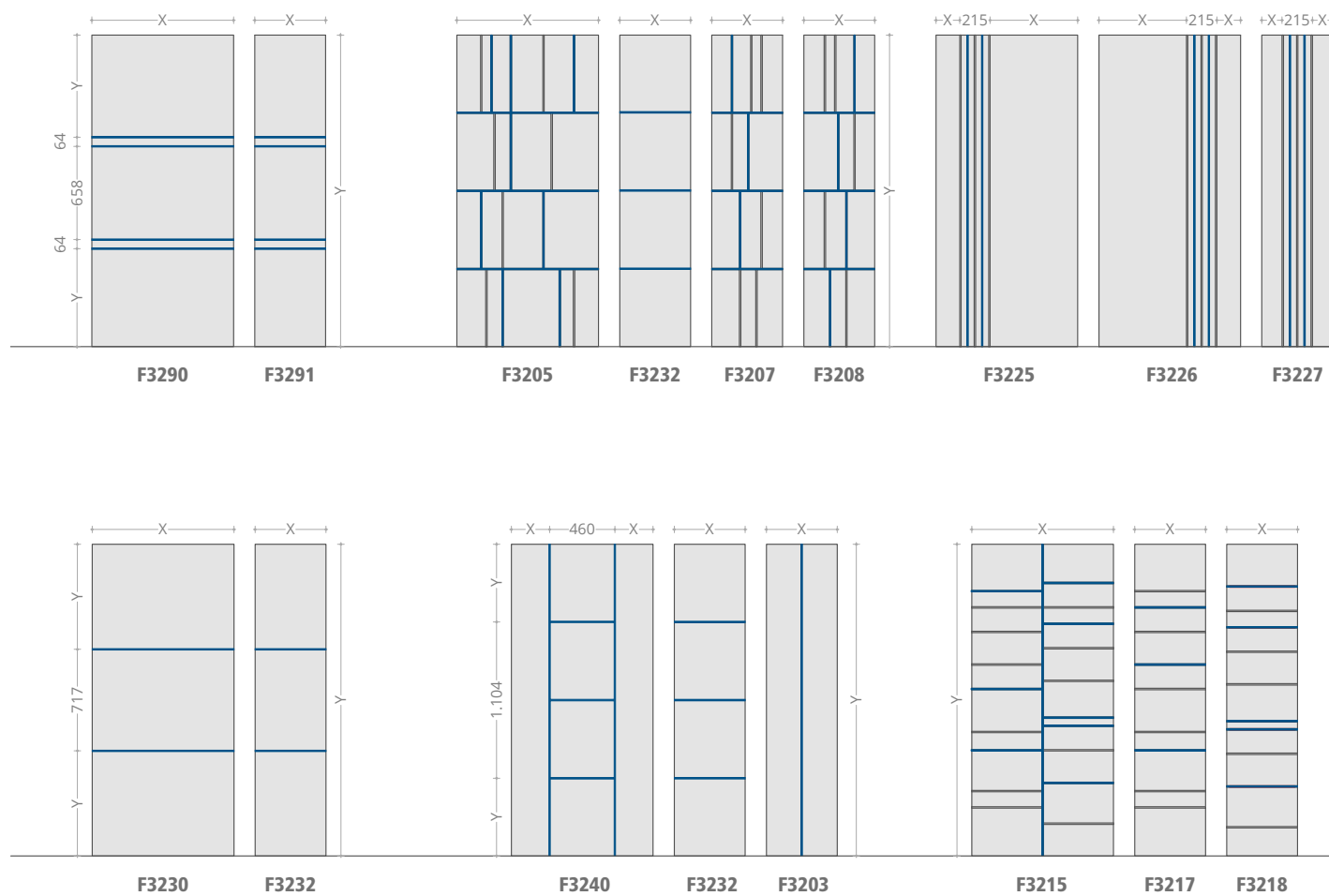

 Inserto in alluminio

I disegni sono rappresentati in scala: 1000 mm di base per 2200 mm di altezza ; *Y* ha valore variabile tra 300 e 900 mm, *X* ha un valore variabile tra 80 mm e 160 mm

# Collezione Linea Trend Con Inserti in Alluminio

Esempi di configurazione in scala 1:20 / 1:20 scale configuration examples

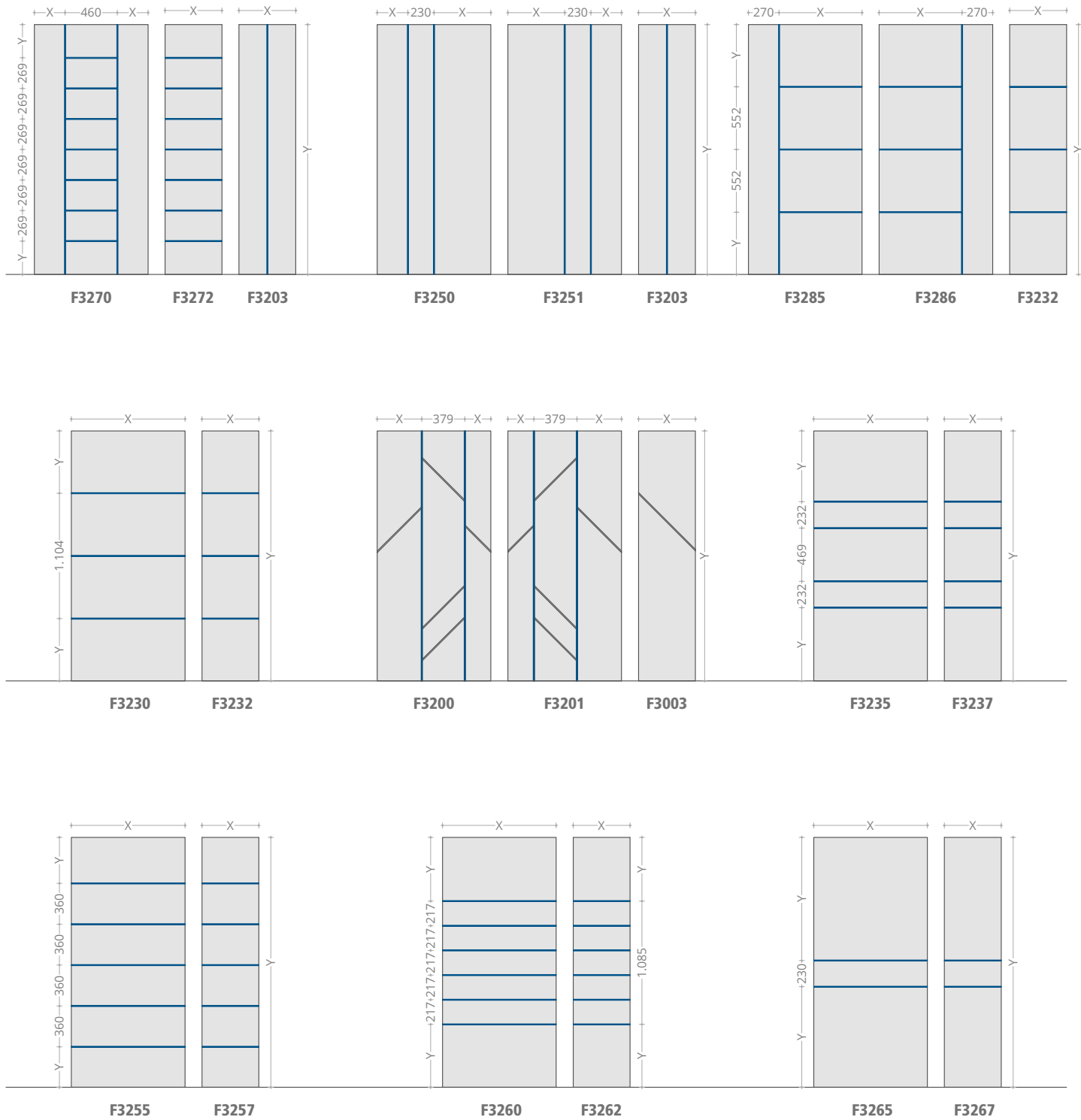

Inserto in alluminio

I disegni sono rappresentati in scala: 1000 mm di base per 2200 mm di altezza ; *Y* ha valore variabile tra 300 e 900 mm, *X* ha un valore variabile tra 80 mm e 160 mm

# Collezione Linea Trend Con Inserti in Alluminio

Esempi di configurazione in scala 1:20 / 1:20 scale configuration examples

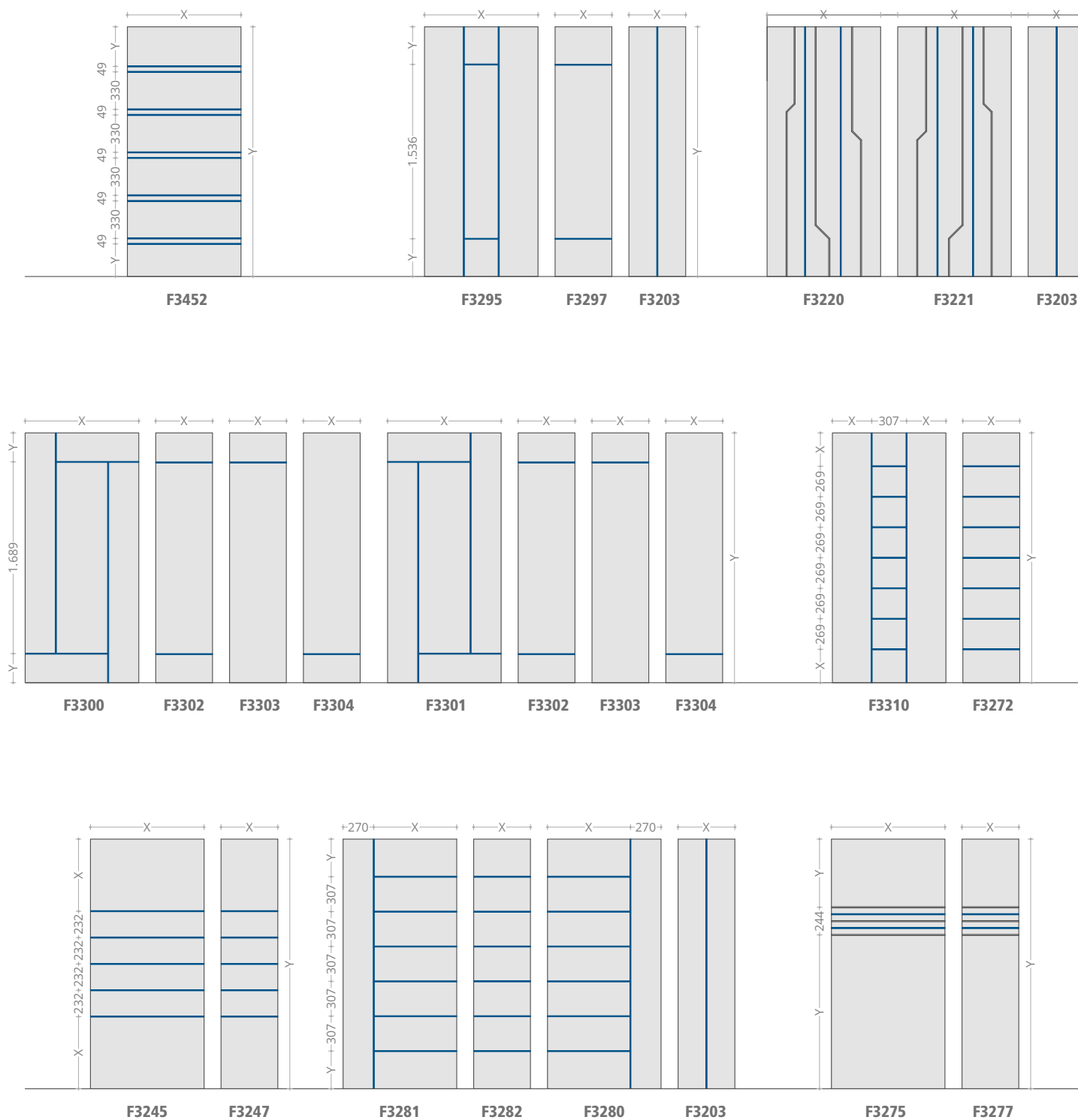

 Inserto in alluminio

I disegni sono rappresentati in scala: 1000 mm di base per 2200 mm di altezza ; Y ha valore variabile tra 300 e 900 mm, X ha un valore variabile tra 80 mm e i 160 mm

# Collezione Linea Vetro

Esempi di configurazione in scala 1:20 / 1:20 scale configuration examples



I disegni sono rappresentati in scala: 1000 mm di base per 2200 mm di altezza ; Y ha valore variabile tra 300 e 900 mm, X ha un valore variabile tra 80mm e i 160 mm

# Collezione Linea Vetro

Esempi di configurazione in scala 1:20 / 1:20 scale configuration examples

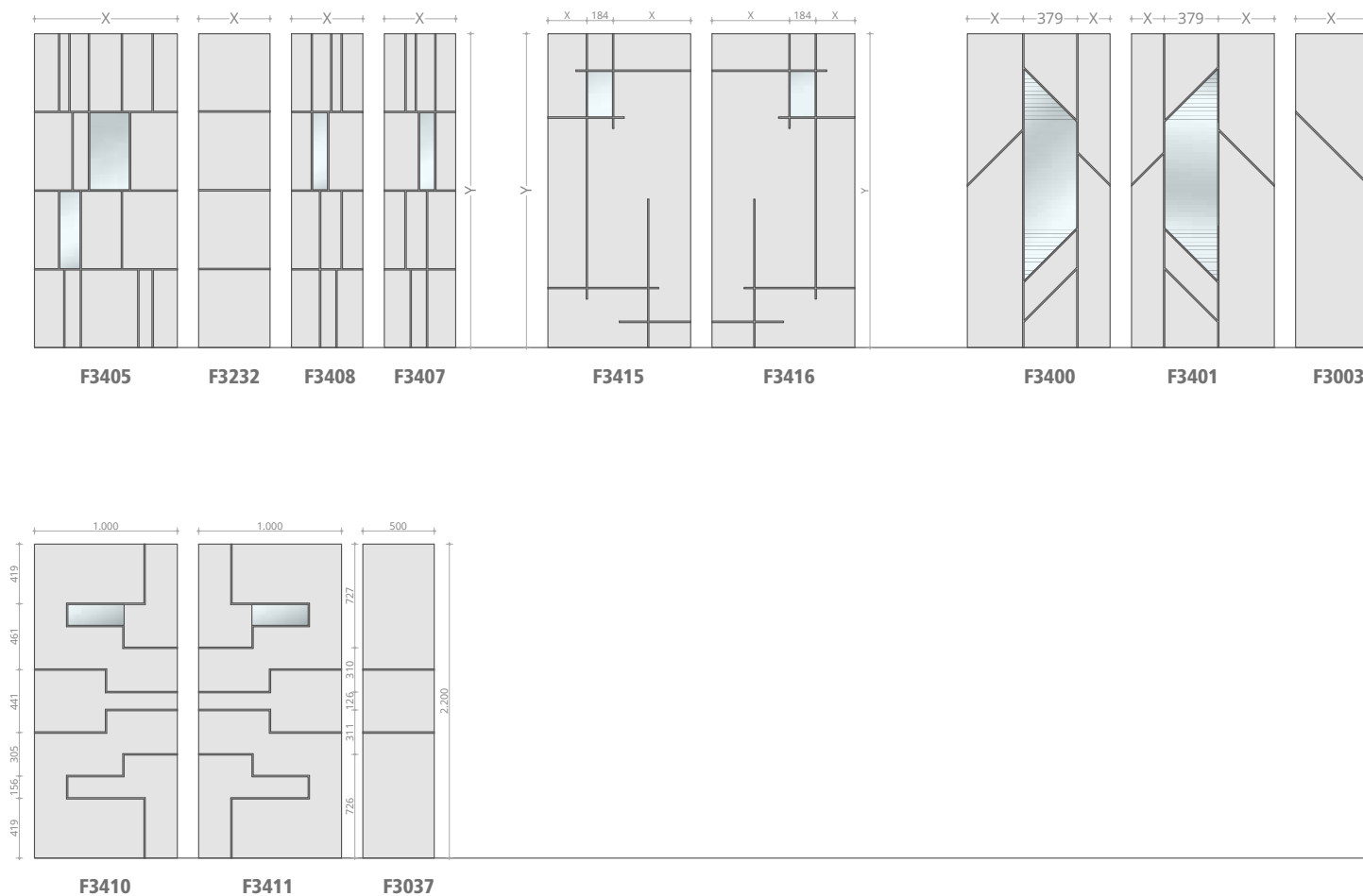

I disegni sono rappresentati in scala: 1000 mm di base per 2200 mm di altezza ; Y ha valore variabile tra 300 e 900 mm, X ha un valore variabile tra 80 mm e i 160 mm

# Collezione Bugnati

Esempi di configurazione in scala 1:20 / 1:20 scale configuration examples

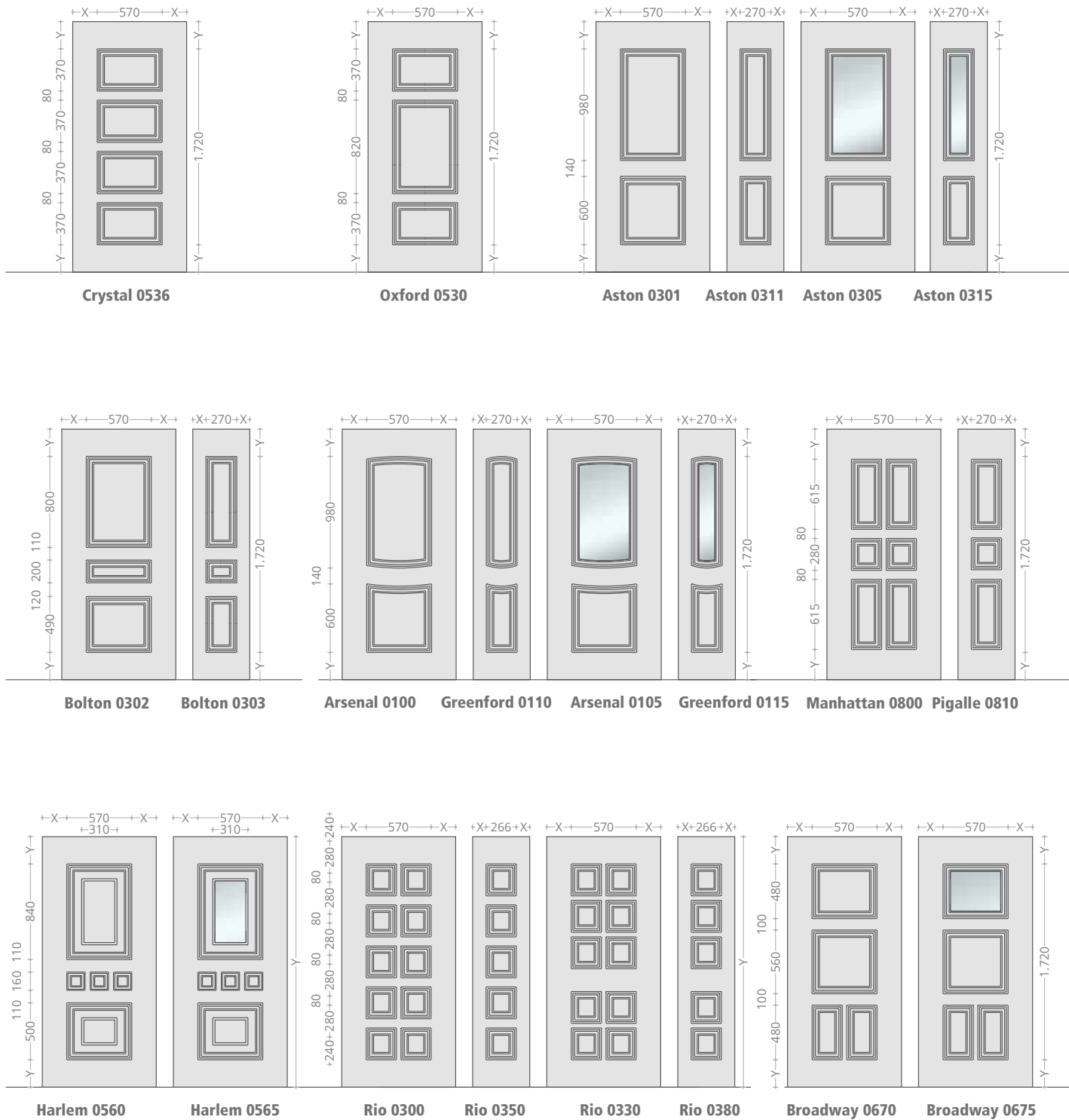

I disegni sono rappresentati in scala: 1000 mm di base per 2200 mm di altezza ; Y ha valore variabile tra 300 e 900 mm, X ha un valore variabile tra 80 mm e i 160 mm

# Collezione Bugnati

Esempi di configurazione in scala 1:20 / 1:20 scale configuration examples

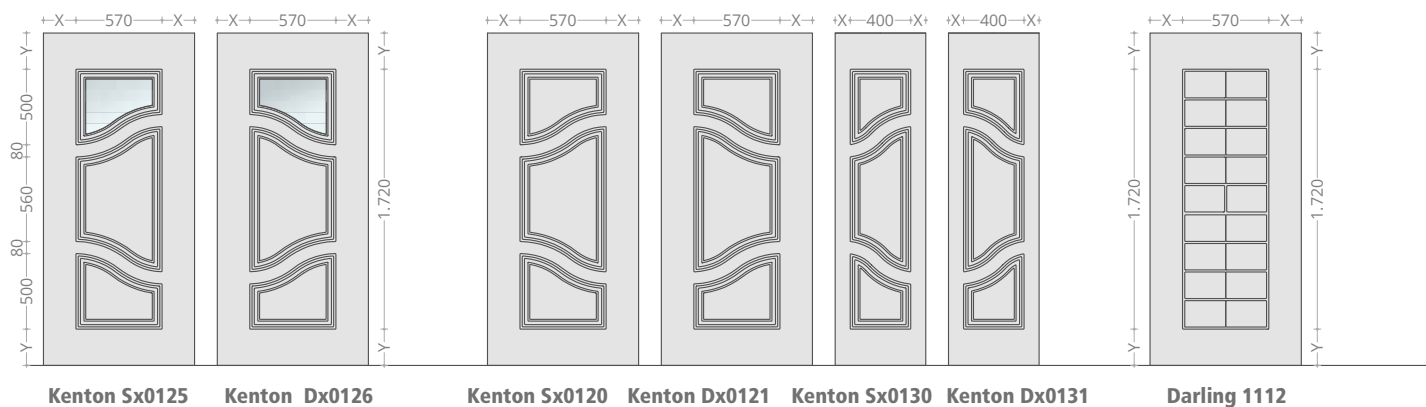
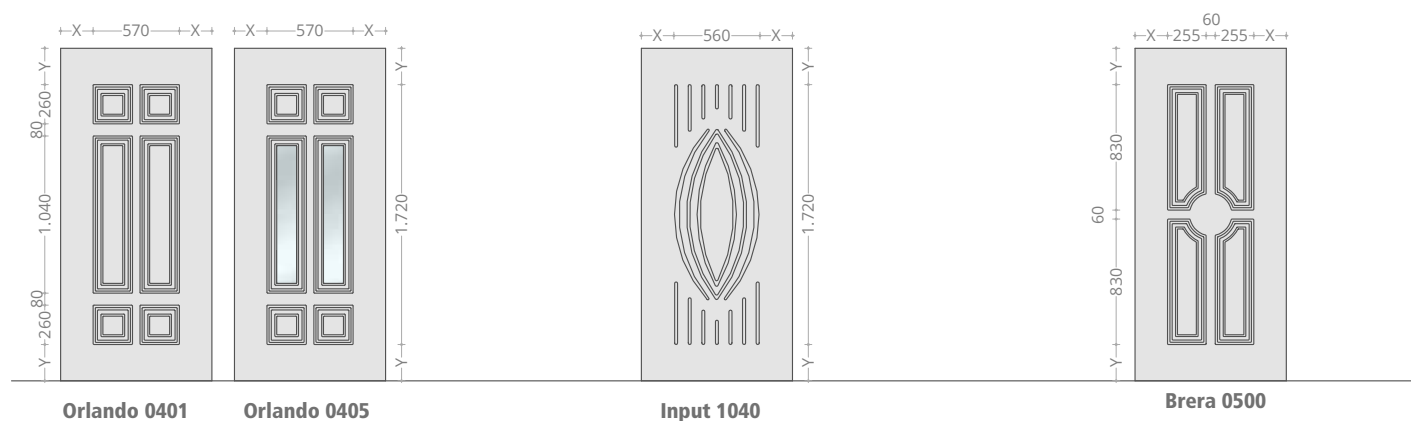
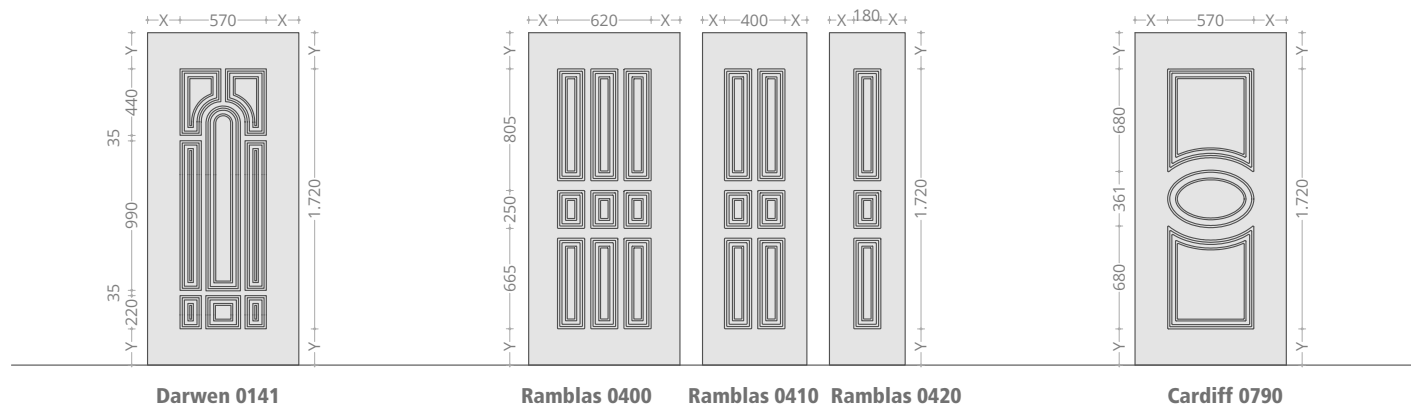

I disegni sono rappresentati in scala: 1000 mm di base per 2200 mm di altezza ;  $Y$  ha valore variabile tra 300 e 900 mm,  $X$  ha un valore variabile tra 80 mm e i 160 mm

# Collezione Bugnati

Esempi di configurazione in scala 1:20 / 1:20 scale configuration examples

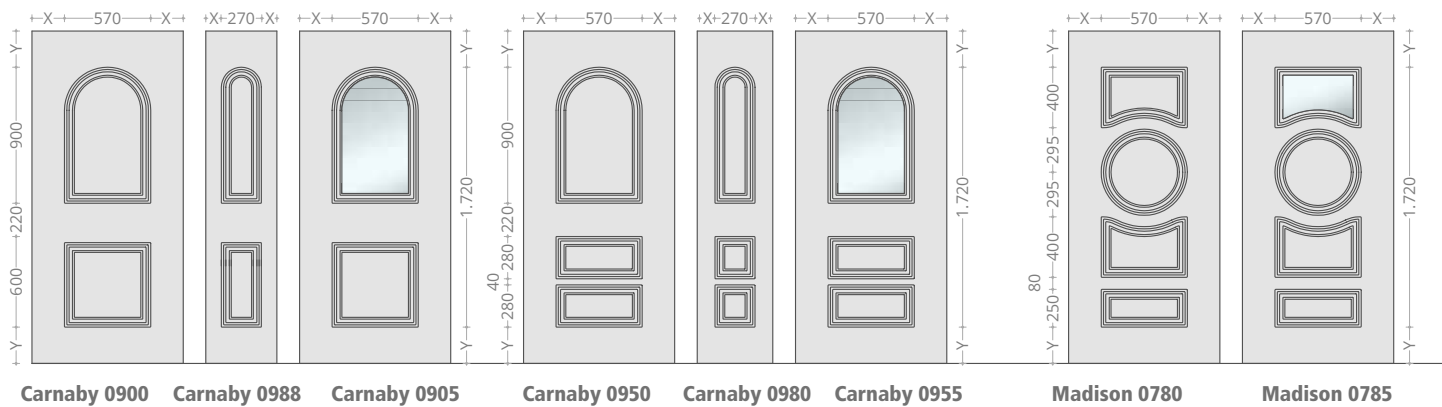
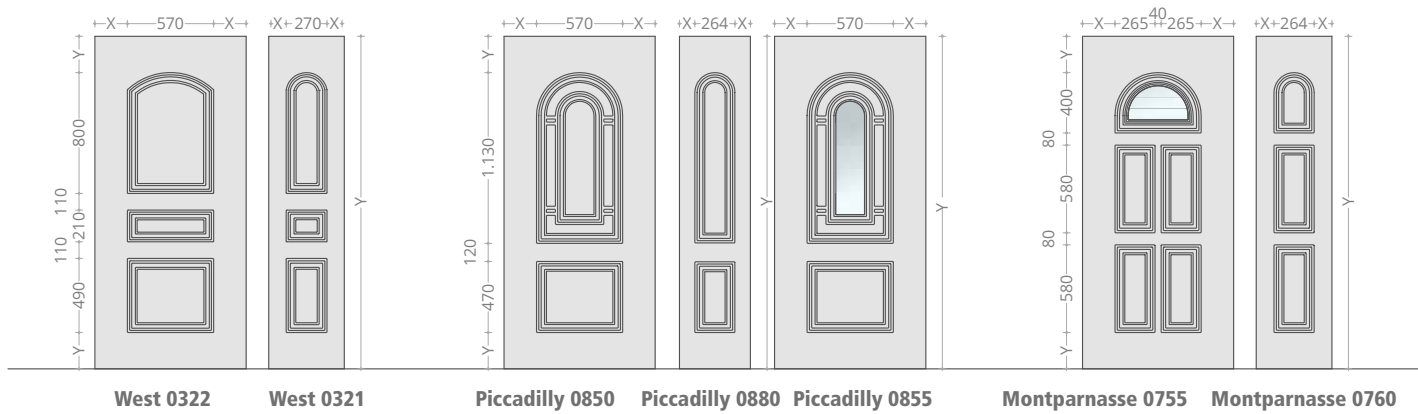
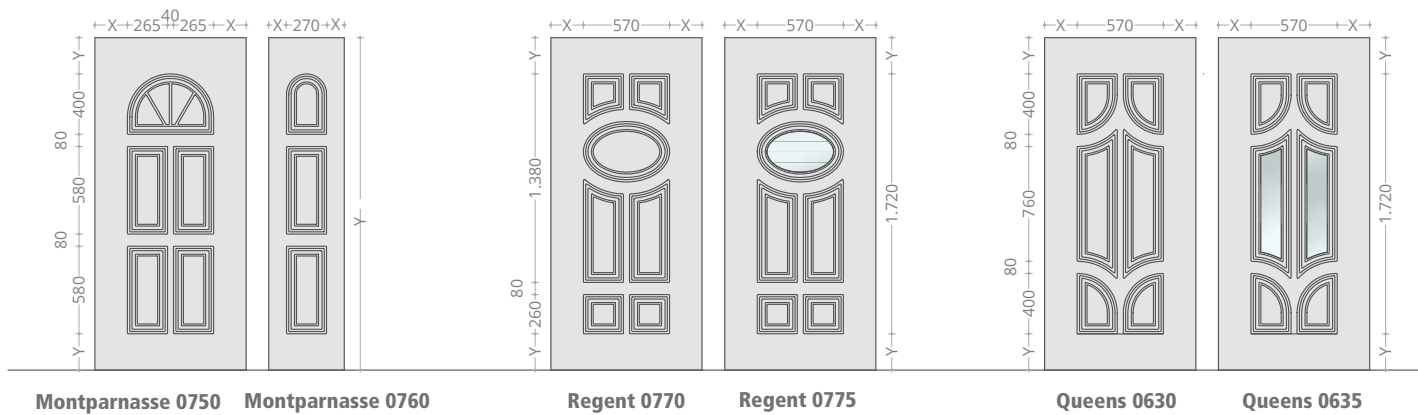

I disegni sono rappresentati in scala: 1000 mm di base per 2200 mm di altezza ; Y ha valore variabile tra 300 e 900 mm, X ha un valore variabile tra 80 mm e i 160 mm



# Collezione Bugnati

Esempi di configurazione in scala 1:20 / 1:20 scale configuration examples



I disegni sono rappresentati in scala: 1000 mm di base per 2200 mm di altezza ;  $Y$  ha valore variabile tra 300 e 900 mm,  $X$  ha un valore variabile tra 80 mm e 160 mm

# Collezione Bugnati

Esempi di configurazione in scala 1:20 / 1:20 scale configuration examples

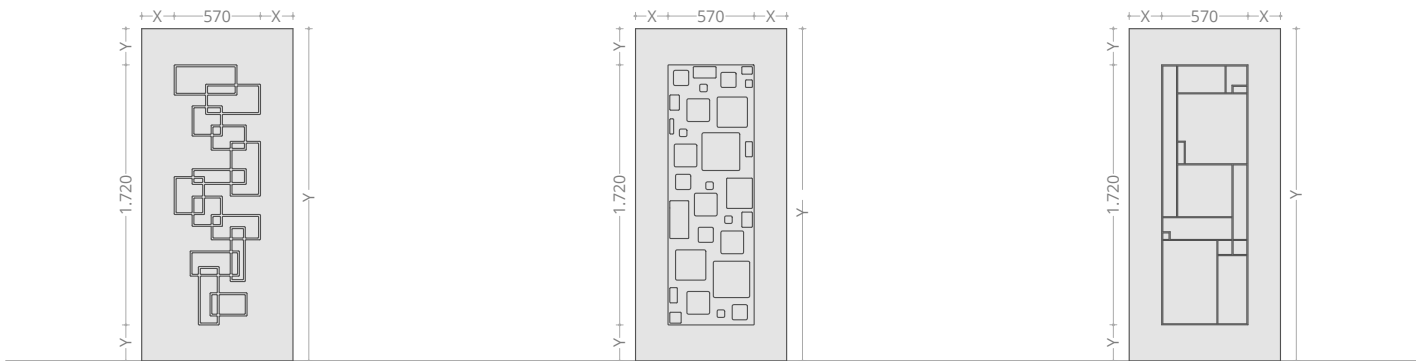

**Minerva 1111**

**Mitte 1113**

**Russel 0540**

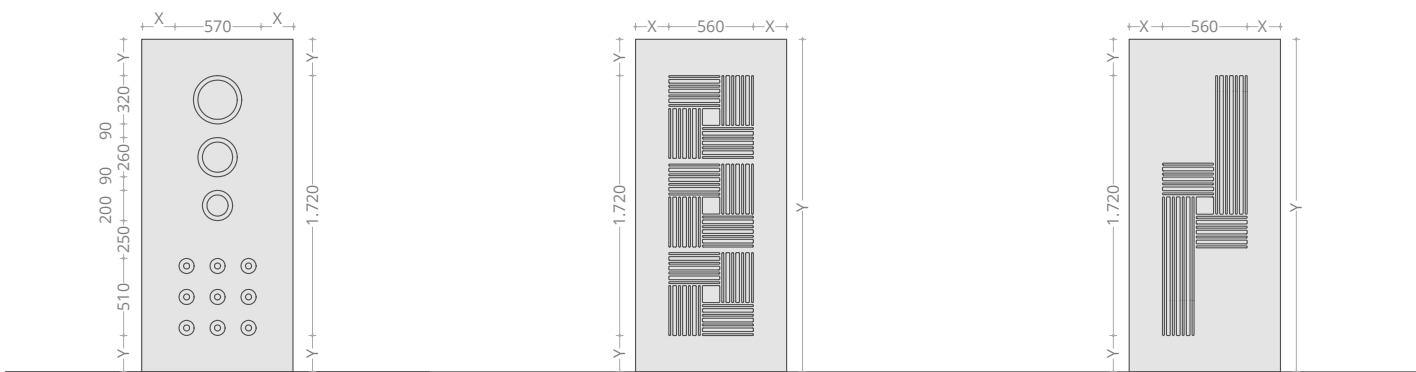

**Concorde 0574**

**Greenwich 1106**

**Brooklyn 1105**

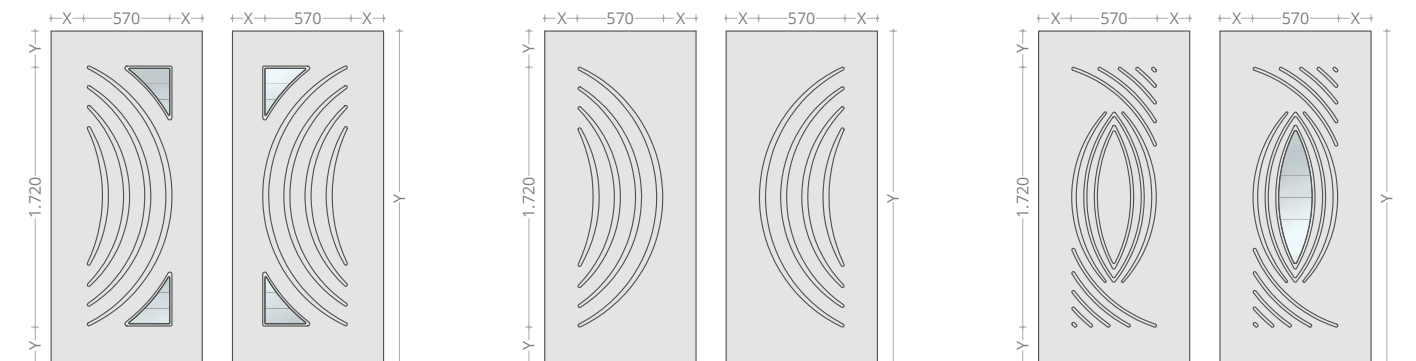

**Precox Sx1015**

**Precox Dx1016**

**Precox Sx1010**

**Precox Dx1011**

**Display 1030**

**Display 1035**

I disegni sono rappresentati in scala: 1000 mm di base per 2200 mm di altezza ; Y ha valore variabile tra 300 e 900 mm, X ha un valore variabile tra 80 mm e i 160 mm

# Collezione Bugnati

Esempi di configurazione in scala 1:20 / 1:20 scale configuration examples

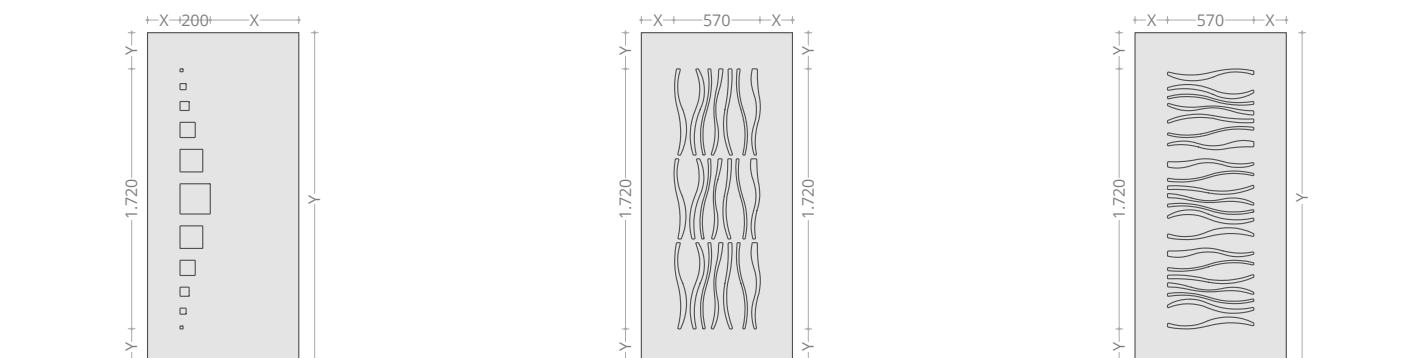

**Shibuya 1110**

**Babila 1102**

**Clotilde 1103**

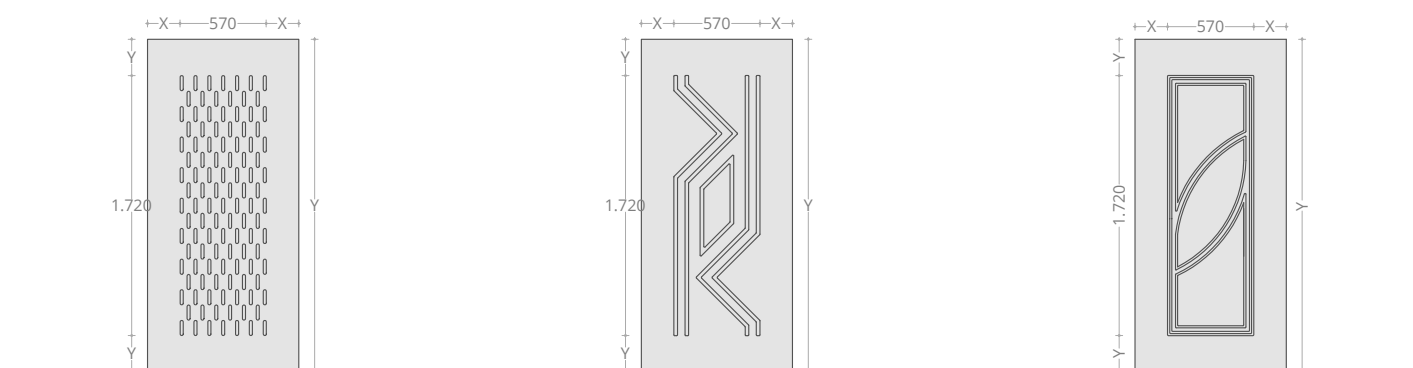

**Mayor 0430**

**Ginza 1104**

**Ueno 1101**

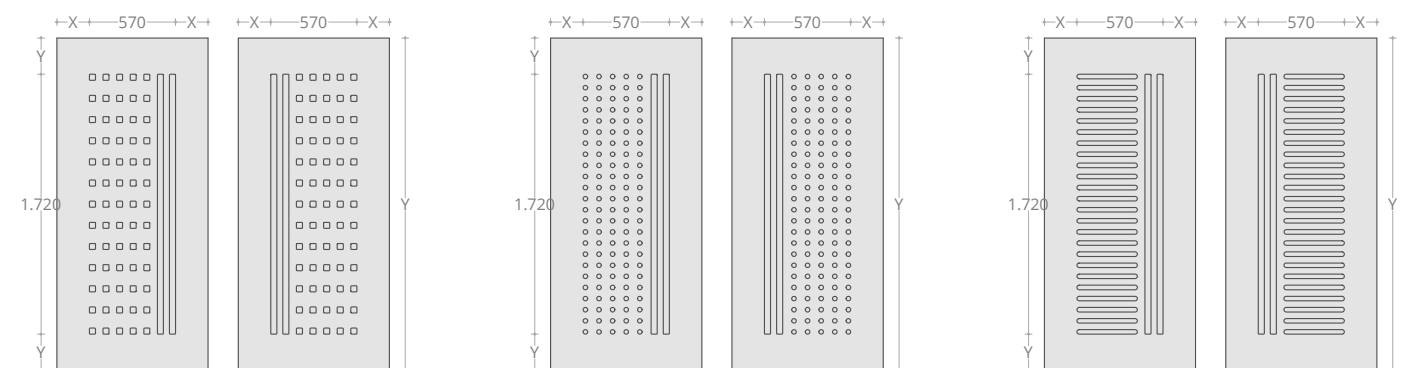

**Bios Sx1080**

**Bios Dx1081**

**Bit Sx1070**

**Bit Dx1071**

**Web Sx1060**

**Web Dx1061**

I disegni sono rappresentati in scala: 1000 mm di base per 2200 mm di altezza ; Y ha valore variabile tra 300 e 900 mm, X ha un valore variabile tra 80 mm e i 160 mm

# Finiture / Finishes

Questione di stile. Nella progettazione degli elementi di facciata la scelta del colore giusto è un aspetto importante. Tenue tinte pastello o brillanti effetti metallizzati. Laccati lisci e lucidi o opachi e naturali. Effetto legno capace di replicare venature dei legni più pregiati. Le finiture Ponzio sono la risposta perfetta al desiderio di raffinata eleganza in casa.

*Matter of style. When designing façade elements, choosing the right color is an important aspect. Soft pastel shades or bright metallic effects. Smooth and glossy or matte and natural lacquers. Wood effect able to replicate veins of the finest woods. Ponzio finishes are the perfect answer to the desire for refined elegance at home.*



Ponzio  
pan  
nel  
i



## Finiture Pannelli

### COLORS ANODIZE

Anodizzato spazzolato

Orofumè - OXORFU. Ottone Fumè - OXOTFU. Bronzo Fumè, OXBRFU. ,Anodizzato ArgentoVunc - OXVUNC. Anodizzato Argento Spazzolato - OXAR. Anodizzato Bronzo Spazzolato -OXBR. Anod. Bronzo Scuro Spazzolato - OXBRSC. Anod. Elettrocolore Chiaro Spazzolato - OXELCH. Anod. Elettrocolore Spazzolato - OXEL. Anod. Nero Spazzolato OXNE.

### Velvet®

Artic Normal - VEATNR. Accioio Normal - VEACNR. Golden Normal - VEGDNR. Grigio Nebbia Normal - VEBGNR. Grigio Fumo Normal - VEGFNR. Granata Normal - VEGRNR. Rame Normal - VERMNR. Bambù Normal -VEBUNR. Zolfo Normal - VEZFNR. Ambra Normal - VEABNR. Piriti Normal - VEPRNR. Sorico Normal - VESTNR. Cerrano Normal - VECRNR. Nero Mat Normal - VENMNR. Blu Elegante Normal - VEBENR.

### STAROX®

Silver 51 - STSI51. Inox Bond 52 -STIB52. Bronzo 51 - STBZ51. Grigio Fly 51 - STGF51. Rosso Passion 51, STRP51. Rum 62 - STRU62. Verde Vali - STVB62. Giallo Oro 514 - STRR51. Brown 51, STBW51. Wood 51 - STWD51. Night 51 STNH51. Blu Ginger 51 - STBG51. Blu Respiro 62 - STBR62.

### TECHNOLOGIES

Verniciato Texture  COLOR

Sabbia 32 EXSN32. Technologies, Bronzo 32, EXBR32. Technologies, Nero Dark 25 - EXNE25. Technologies, Argento Moda 25 EXA25. Technologies, Vulcano 25 - EXVC25.

### SOFT Touch

Jaguar 11 - THJA11. Soft Touch, Koala 11- THKA11. Soft Touch, Shark 11, THSH11. Soft Touch, Tiger11 - THTG11.

## Finiture Pannelli



Acciaio Chiaro - CHACC. Grigio Metallizzato - MEGRI. Bianco Marezzato - BIMAR. Verde Micaceo - MIVER. Ferro Micaceo - FEMIC. Alluminio 9006. Alluminio Micaceo - 9007. Marrone Corten - CORMAR. Thai 21 - THA21. Thai 24 - THA24. Bianco Grinz - GRIBI. Bianco Fumo Grinz - GRIBFU. Verde Chiaro Grinz - GRIVEC. Verde Grinz - GRIVE. Grigio Chiaro Grinz - . Grigio Grinz - GRIGR. Marrone Grinz - GRIMA. Marrone Scuro Grinz - GRIMSC. Nero Grinz - GRINE. Verde Antico - ANVER. Oliver 16 - OL16. Verde Rustico - RUVER. Oliver 06 - OLO6. Marrone Rustico RUMAR. Grigio Polvere M7000. Verde Polvere - M7100. Marrone Polvere - M7200.



Snow - MBSW51. Lana - MBLN51. Kaki Sand - MBKA11. Cera Sand - MBCA11. Ecrù Sand - MBER11. Baita Sand - MBBT11. Cemento Sand - MBCT11. Verona - MBVR11. Terra di Siena 11 - MBTS11. Rosa Fumè 11 - MBRF11. Marrone Brillante 11 - MBMR11. Blu Brillante - MBBR11. Nero Brillante 11 - MBNR11. Verde Bosco 11 - MBVB11. Cobalto Brillante 11 - MBCB11. Vino 11 - MBVN11. Gris 11 - MBGS11.



Specchio Fine - BDSH51. Iron Fine - BDRN51. Gold Fine - BDLD51. Grigio Reale Fine - BDGE51. Grigio Tungsteno Fine - BDTG51. Amaranto Fine - BDAM51. Cannella Fine - BDCN51. Olio Fine - BDLO51. Sole Fine - BDSL51. Zafferano Fine - BDZR51. Lingotto Fine - BDNG51. Ruggine Fine - BDGG51. Grigio Ardesia Fine - BDGR51. Blu Persia Fine - BDBP51. Blu Klein Fine - BDBK51.

**Ultra:** Gold Ultra - BDLD11. Grigio Reale Ultra - BDGE11. Specchio Ultra - BDSH11. Iron Ultra - BDRN11. Amaranto Ultra - BDAM11. Cannella Ultra - BDCN11. Brased Ultra, Olio Ultra - BDLO11. Brased Ultra, Sole Ultra - BDSL11. Brased Ultra, Zafferano Ultra - BDZR11. Brased Ultra, Lingotto Ultra - BDNG11. Ruggine Ultra - BDGG11. Grigio Ardesia Ultra - BDGR11. Blu Persia Ultra - BDBP11. Blu Klein Ultra - BDBK11.

## Finiture Pannelli

### Uberall<sup>®</sup>HD

Noce 25 - HDNC25. Noce 35 - HDNC35. Castagno 35 - HDCS35. Ebano 35 - HDEB35. Sipo 35 - HDSP35. Bahia 35 - HDBH35. Platano 35 - HDPL35. Pioppo 35 - HDPP35. Ulivo 15 - HDUV15. Olmo 15 - HDOM15. Renolit 35 - HDRN35. Rovere 25 - USRV25. Rovere 15 - USRV15. Ciliegio 45 - USCI45. Rovere 35 - USRV35. Tuia - HDTU35.

### Uberall<sup>®</sup>

Larice Opaco 11 - UBLR11. Noce Opaco 41 - UBNC41. Noce Opaco 43 - UBNC43. Noce Opaco 45 - UBNC45. Rovere Opaco 41 - UBRV41. Noce Opaco 44 - UBNC44. Wengè - UBWE11. Castagno Opaco 41 - UBCS41. Iroko Opaco 41 - UBIR41. Renolit Opaco 11 - UBRN11. Renolit Opaco 21 - UBRN21. Ciliegio Opaco 42 - UBCI42. Ciliegio Opaco 31 - UBCI32. Douglas Opaco 31 - UBDU31. Pino Opaco 31 - UBPI31. Rovere Opaco 44 - UBRV44. Legno Bianco 24 - UBBI24. Bianco 25 - UBBI25. Legno Verde 24 - UBVE24.

### VERTEX<sup>®</sup>

Rovere 28/3d -VXRV28. Noce 38/3d - VXNC38. Corten 13/3d - VXCR13. Corten 16/3d - VXCR16. Corten 17/3d - VXCR17.

### Ral Verniciato lucido e opaco

**Ral di Serie:** Ral 1013 - 1013. Ral, Bianco Perla Opaco - K1013. Ral, Ral 9001 - 9001. Ral, Bianco Crema Opaco - K9001. Ral, Ral 9010 - 9010. Ral, Bianco Puro Opaco - K9010. Tutti i Ral Lucidi e Opachi su richiesta

## Finiture Inserti 10 mm e 2 mm per pannelli Plana

**Inserto 10 mm. :** RAL 9010, K 9010, UBNC43 Noce 43, UBCI42 Ciliegio 42, OXNE Anodizzato Nero, STIB52 Inox Bond 52, BDRN11 Iron, BDTG11 Grigio Tungsteno

**Inserto 2 mm. :** RAL 9010, K 9010, OXNE Anodizzato Nero, STIB52 Inox Bond 52, BDRN11 Iron, BDTG11 Grigio Tungsteno

## Finiture Inserti 10 mm per pannelli Linea

**Inserto 10 mm. :** STIB52 Inox Bond 52

---



# Disponibilità Finiture Pannelli per Collezioni

Sezione Tecnica

Availability Panels Finishes for Collections

Finiture Finishes	Collezioni Pannelli Ponzio					
	Plana	Linea	Linea Inserti	Linea Vetro	Bugnati	Bugnati Vetro
<b>Anodize</b>	●	●	●	●	●	●
<b>Velvet</b>	●	●	●	●		
<b>Starox</b>	●		●			
<b>Technologies</b>	●	●	●	●	●	●
<b>Soft Touch</b>	●	●	●	●	●	●
<b>Polycrom</b>	●	●	●	●	●	●
<b>Marbel</b>	●	●	●	●	●	●
<b>Brased</b>	●	●	●	●	●	●
<b>Brased Ultra</b>	●	●	●	●	●	●
<b>Uberal HD</b>	●		●		●	●
<b>Uberal</b>	●		●		●	●
<b>Vertex</b>	●	●	●		●	●
<b>RAL</b>	●	●	●	●	●	●

- Finitura con effetto omogeneo su tutto il pannello
- Finitura con effetto non omogeneo tra superficie pannello e fresatura ma comunque disponibile



**MODIFICHE:**

La Ponzio S.r.l. si riserva il diritto di applicare e produrre tutte le modifiche tecniche e migliorative ai suoi prodotti, senza l'obbligo del preavviso.

**RIPRODUZIONI**

E' vietata la riproduzione, anche parziale, del presente catalogo, senza espressa autorizzazione scritta da parte della Ponzio S.r.l.

**BREVETTI:**

I modelli presentati in questo catalogo sono protetti da brevetto. La Ponzio S.r.l. ha l'esclusiva della produzione e la commercializzazione dei modelli oggetto di brevetto. Interverrà, pertanto, in occasione di eventuali violazioni dei propri diritti, con i mezzi previsti dalle leggi vigenti in materia di brevetti.

**CHANGES:**

*The Ponzio srl reserves the right to apply and produce all technical and constructive changes to its products, without obligation of notice.*

**COPYING:**

*Copies prohibited, even partial, of this catalog, without the express written permission of Ponzio srl*

**PATENT:**

*The models presented in this catalog are protected by patents. The Ponzio srl has exclusive production and marketing of patented products models. Intervene, therefore, in the event of any violations of their rights, by the means provided by the laws on patents.*

**PONZIO S.R.L.**

Via dei Fabbri - Z. I.  
64025 Pineto (TE) Italy  
Tel. +39 085-94641  
info@ponzioaluminium.com  
www.ponzioaluminium.com

follow us:







**PONZIO S.R.L.**

Via dei Fabbri - Z. I.  
64025 Pineto (TE) Italy  
Tel. +39 085-94641  
[info@ponzioaluminium.com](mailto:info@ponzioaluminium.com)  
[www.ponzioaluminium.com](http://www.ponzioaluminium.com)

